

# DUCAR

## USER MANUAL LAWNMOWER

MODEL NO:DM53SE-DV173



### CAUTION

Before using our gasoline lawn mower, please read this manual carefully to understand the proper use of your unit. Keep this manual handy.

Original Instructions

## TABLE OF CONTENTS

---

<b>Description of Product Parts .....</b>	<b>3</b>
<b>Technical Specifications .....</b>	<b>4</b>
<b>Intended use &amp; Warranty .....</b>	<b>4</b>
<b>Safety Information.....</b>	<b>5</b>
<b>Assembly .....</b>	<b>9</b>
<b>Adjustment .....</b>	<b>13</b>
<b>Operation .....</b>	<b>14</b>
<b>Storing and Maintenance .....</b>	<b>22</b>
<b>Troubleshooting .....</b>	<b>27</b>

## DESCRIPTION OF PRODUCT PARTS

As shown in Fig 1

1. Drive lever (clutch lever)
2. soft grip
3. Upper handle
4. Brake lever /stop lever
5. Fixing knob with square neck blot
6. Lower handle
7. Grass box
8. Fuel tank cap
9. E-start button
10. Front decorative cover
11. Height adjusting handle
12. Rear wheel
13. Engine oil cap
14. Side discharge cover
15. Side discharge chute
16. Deck
17. Spark plug boot
18. Starter handle
19. Rear discharge cover
20. Front wheel
21. throttle control

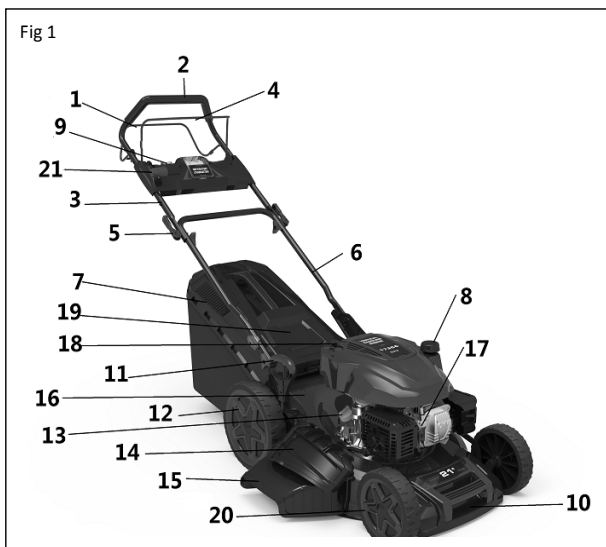

## TECHNICAL SPECIFICATIONS

Engine type	Single cylinder 4-stroke	
Engine displacement	173cc	
Engine max.power	3.3KW/2800 rpm	
Engine speed	2800 rpm	
Cutting width	530mm	
Grass bag capacity	70L	
Fuel tank	1800±200ml	
Oil tank	550±50ml	
Battery Parameters:	DC12V2000mAh	
Battery charger Parameters:	Input AC100~120V 50~60Hz, output DC12.6V-1.5A	
Net weight	<b>37KG</b>	
Noise Data		
Sound power level (LWA)*	98dB(A)	

## INTENDED USE & WARRANTY

This Petrol lawn mower has been designed for cutting lawn areas in private house and hobby gardens. (residential use only)

The manufacturer warrants the product 12 months from the date of purchasing, from all fabrication faults. The lawnmowers that are used in a professional or locative way are not warranty. The warranty cannot be claimed in case of normal wear.

The manufacturer will replace at his expense the spare parts, which would be classified as defective by him or an agreed station service. In any case the manufacturer will not accept the reimbursement of the machine (partially or totally) and/or damages and interest direct or indirect.

### The warranty does not cover :

- An insufficient maintenance
- An abnormal use or damage due to shocks
- The mounting, adjustment and preparation of the machine
- The spare parts with normal wear, security spare parts (belt, blade, blade support, bearings, cables, deflectors, spark plug, air filter etc...)
- Freight and packing cost

The manufacturer will refuse any responsibility if the machine was not used for the purpose it was made or if the operator did not use the machine as describe in the operations and maintenance rules in the owner manual.

Read carefully the instruction manual before any use of the lawnmower.

For all spare parts order you must specify the reference of the mower the construction year, the serial number of the mower and of the engine.

## SAFETY INFORMATION

### IMPORTANT

Please read these instructions fully before assembling and operating.

#### Description Of Symbols

Symbols are used in this manual to attract your attention to possible risks. The safety symbols and the explanations which accompany them must be perfectly understood. The warning themselves do not prevent the risks and cannot be a substitute for proper methods of avoiding accidents.

#### Warning symbols on the machine



WARNING- To reduce the risk of injury ,user must read instruction manual.



This symbol, before a safety comment, indicates a precaution, a warning or a danger. Ignoring this warning can lead to an accident for yourself or for others. To limit the risk of injury, fire, or electrocution always apply the recommendations indicated.



Keep by standers away



Beware of sharp blades –remove spark plug lead before maintenance



Never refuel while the engine is running



Risk of injury . do not open or remove safety shields while engine is running.

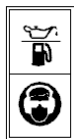

Wearing ear protection , eye protection when operating.



Hot surfaces will burn fingers or palms



Warning! The lawnmower exhaust gas contains toxic substances . do not run the engine in closed or poorly ventiated areas.



Guaranteed sound power level



Waste electrical products should not be disposed of with household waste. Please recycle where facilities exist. Check your local authority or retailer for recycling advice.

## **Safety instructions.**

### **Training**

1. Read the instructions carefully. Be familiar with the controls and the proper use of the equipment;
2. Never allow children or people unfamiliar with these instructions to use the lawnmower. Local regulations can restrict the age of the operator;
3. Never mow while people, especially children, or pets are nearby;
4. Keep in mind that the operator or user is responsible for accidents or hazards occurring to other people or their property.

### **Preparation**

1. While mowing, always wear substantial footwear and long trousers. Do not operate the equipment when barefoot or wearing open sandals;
2. Thoroughly inspect the area where the equipment is to be used and remove all objects which can be thrown by the machine;
3. Warning - petrol is highly flammable.
  - Store fuel in containers specifically designed for this purpose;
  - Refuel outdoors only and do not smoke while refueling;
  - Add fuel before starting the engine. Never remove the cap of the fuel tank or add petrol while the engine is running or when the engine is hot;
  - If petrol is spilled, do not attempt to start the engine but move the machine away from the area of spillage and avoid creating any source of ignition until petrol vapours have dissipated;
  - Replace all fuel tank and container caps securely;
4. Replace faulty silencers;
5. Before using, always visually inspect to see that the blades, blade bolts and cutter assembly are not worn or damaged. Replace worn or damaged blades and bolts in sets to preserve balance;
6. On multi-bladed machines, take care as rotating one blade can cause other blades to rotate.

### **Operation**

1. Do not operate the engine in a confined space where dangerous carbon monoxide fumes can collect;
2. Mow only in daylight or in good artificial light;
3. Avoid operating the equipment in wet grass, where feasible;
4. Always be sure of your footing on slopes;
5. Walk, never run;
6. For wheeled rotary machines, mow across the face of slopes, never up and down;
7. Exercise extreme caution when changing direction on slopes;
8. Do not mow excessively steep slopes;
9. Use extreme caution when reversing or pulling the lawnmower towards you;
10. Stop the blade(s) if the lawnmower has to be tilted for transportation when crossing

surfaces other than grass, and when transporting the lawnmower to and from the area to be mowed;

11. Never operate the lawnmower with defective guards, or without safety devices, for example deflectors and/or grass catchers, in place;
12. Do not change the engine governor settings or over speed the engine;
13. Disengage all blade and drive clutches before starting the engine;
14. Start the engine or switch on the motor carefully according to instructions and with feet well away from the blade(s);
15. Do not tilt the lawnmower when starting the engine or switching on the motor, except if the lawnmower has to be tilted for starting. In this case, do not tilt it more than absolutely necessary and lift only the part which is away from the operator;
16. Do not start the engine when standing in front of the discharge chute;
17. Do not put hands or feet near or under rotating parts. Keep clear of the discharge opening at all times;
18. Never pick up or carry a lawnmower while the engine is running;
19. Stop the engine and disconnect the spark plug wire, make sure that all moving parts have come to a complete stop and, where a key is fitted remove the key:
  - Before clearing blockages or unclogging chute;
  - Before checking, cleaning or working on the lawnmower;
  - After striking a foreign object. Inspect the lawnmower for damage and make repairs before restarting and operating the lawnmower;
  - If lawnmower starts to vibrate abnormally (check immediately);
20. Stop the engine and disconnect the spark plug wire, make sure that all moving parts have come to a complete stop and, where a key is fitted remove the key:
  - Whenever you leave the lawnmower;
  - Before refueling;
21. Reduce the throttle setting during engine shut down and, if the engine is provided with a shut-off valve, turn the fuel off at the conclusion of mowing;
22. Go slow when using a trailing seat.

## Maintenance and storage

1. Keep all nuts, bolts and screws tight to be sure the equipment is in safe working condition;
2. Never store the equipment with petrol in the tank inside a building where fumes can reach an open flame or spark;
3. Allow the engine to cool before storing in any enclosure;
4. To reduce the fire hazard, keep the engine, silencer, battery compartment and petrol storage area free of grass, leaves, or excessive grease;
5. Check the grass catcher frequently for wear or deterioration;
6. Replace worn or damaged parts for safety;
7. If the fuel tank has to be drained, this should be done outdoors.



## ASSEMBLY

### Assembling the handle

As shown in Fig 3 & 4

1. Fasten the lower handle to the device by using two bolts and two small knobs on each side.
2. Unfold the upper handle and fix it to lower handle by using the big knobs and the bolts on each side.
3. Adjust the traction cable : Make sure the lever is fully engage on the gearbox.
4. Adjust the safety break cable : Make sure the engine stop right after you let go the handle. The cable should not be under any tension after the handle is release.



**NOTE** :Make sure the rope guide is on the right handle, when you stand behind the mower.

Fig 3

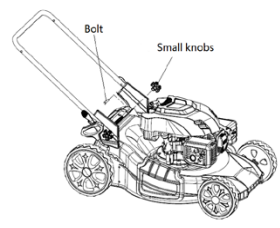
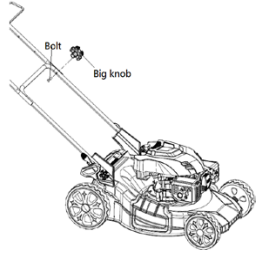

Fig 4



### Tidy the connection cord

As shown in Fig 5

Fix the connection cord to the handle  
With the cord clip ,(supplied)

Fig 5

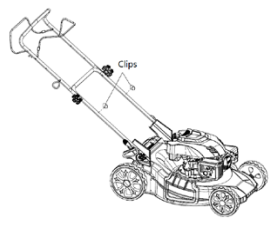

### Assembling the grass bag

As shown in Fig 6

1. Clip the plastic clips over the metal frame. Make sure that these clips are fully secured to the metal frame.

Fig 6

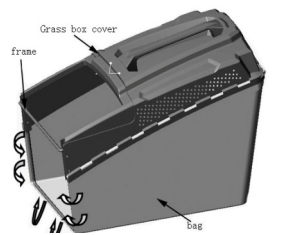

### Assembling the grass bag onto the mower

As shown in Fig 7

1. Lift the rear discharge cover with one hand and hook in the grass bag .
2. Release the rear discharge cover to secure the grass bag in position

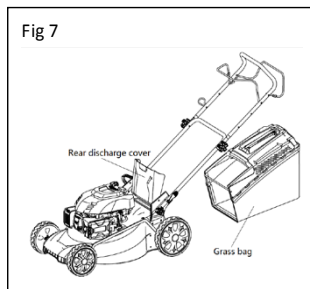

### Assembling the mulching plug

As shown in Fig 8

1. Remove the grass bag
2. Push the plastic mulching plug Into the discharge chute Until it is locked in place.
3. Then release the flap, it will close Back to cover the mulching plug.

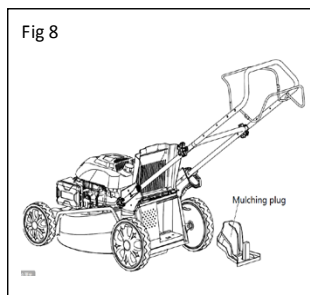

### Assembling the side discharge chute

As shown in Fig 9



**NOTE :** When use side discharge function .  
First need remove the grass Bag and plug the mulching plug.

1. According to the pictures show the way ,Lift the side discharge cover with One hand and hook in the side discharge Duct with the other hand.
2. Release the side discharge cover to secure the duct in position

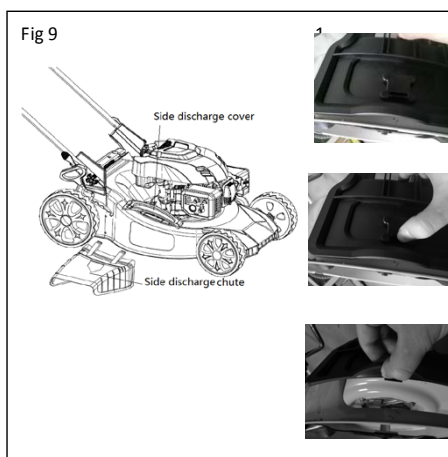

### Checking the engine oil level 1And filling with engine oil

As shown in Fig 11 -13

**CAUTION!** The following procedures and adjustments must be performed before the engine is started.  
Do not attempt to make any of these adjustments while the engine is running.

**CAUTION!** To prevent engine damage the engine is shipped without oil or petrol. The engine must be filled with the correct grade of oil and petrol before starting the engine.

**NOTE!** Running the engine with a low oil level will cause engine damage. It is recommend that high detergent, premium quality 4-stroke engine oil used. Using non-detergent oil can shorten the engine's service life and using 2-stroke oil will damage the engine.

**CAUTION!** Always use high quality detergent oil classified SAE30 oil (or equivalent e. g SAE 10W/30, often termed as 4 Stroke lawn mower oil). Never use additives with recommended oil. To prolong the life of your engine it is important that the oil is changed after the first 5 hours of use.

**NOTE :**To Check the engine oil level ,stop engine and place the mower on a level surface.

1. Remove the oil filler dipstick and wipe oil from it with a clean cloth.
2. Insert the dipstick into the oil filler neck, but do not turn it in.
3. Then remove the dipstick and check the oil Level . the oil level must be between the

Fig 12

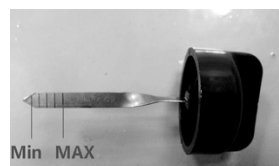
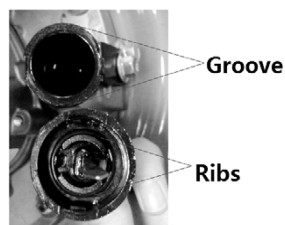

Fig 13



Min and Max marks on the dipstick. If near the lower level ,fill to upper lever with the recommended oil((SAE30 or equivalent).

Do not overfill. Wipe away any spilt oil.)

4. Align the ribs of the cap with the groove of the filler neck . then rotate 1/4 turn to secure it.

### Filling with engine fuel

As shown in Fig 14



**CAUTION!** Always use clean, fresh unleaded petrol. Purchase fuel in quantities that can be used within 30 days. Never mix oil with petrol.



**CAUTION!** Do not fill into the base of neck to allow for fuel expansion. Do not overfill the fuel tank.



**CAUTION! WARNING!** Petrol is highly flammable and extreme precaution must be taken when handling or working with it. Keep out of reach of children.



**CAUTION!** To prevent engine damage the engine is shipped without oil or petrol. The engine must be filled with the correct grade of oil and petrol before starting the engine.



**WARNING!** Refuel in a well-ventilated area with the engine stopped. Do not smoke or allow flame or sparks in the area where the engine is refueled or where petrol is stored. Avoid repeated or prolonged contact with skin or inhalation of vapour

1. Clean the area around the petrol filler cap before removing the cap. Remove the warning tag, check the fuel level.
2. Refill the tank if the fuel level is low.
3. Refuel carefully to avoid overfilling or spilling fuel. There should be no fuel in the filler neck.
4. Clean up any overflow or splashes of petrol before starting the engine.
5. Tighten the filler cap after filling, finger tight on.

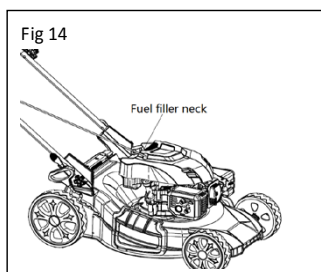

## ADJUSTMENT

### Setting the cutting height

As shown in Fig 15



**CAUTION !** Adjust the cutting height only when the engine is switched off and the spark plug boot has been pulled.

The cutting height is centrally adjusted with the cutting height adjusting handle. Different cutting heights can be selected.

Pull the adjusting handle out and select the desired cutting height. The handle snaps into the desired position.

From position 1 to position 7. The cutting height range is from 25mm to 75 mm.

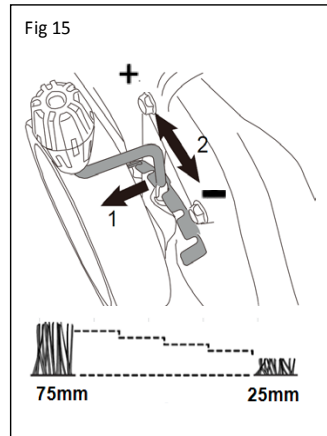

### Setting required function



**NOTE:** This lawn mower has three functions. These functions can be converted by changing accessory settings. Please see the following chart for detail settings.

To convert mower	mulching plug	Grass bag	side discharge duct
For rear discharging	x	x	x
For rear bagging	x	√	x
For mulching	√	x	x
For side discharging	√	x	√

“√”: installed    “x”: removed

## OPERATION

### Start and stop the engine

**WARNING** : the blade begins to rotate  
As soon as the engine is started.

**NOTE** : do not operate the machine in enclosed or poorly ventilated areas as the exhaust gas contains toxic substance.  
Keep hands , feet ,hair and clothing away from  
All the moving parts of the machine . the exhaust and other  
Parts of the machine will become hot during use.  
Make sure that the blade is securely fastened before  
Starting the engine.

**NOTE** : to start the engine , make sure that the spark  
Plug boot is located on the plug and the machine is  
filled with sufficient oil and petrol.

### To start the engine

As shown in Fig 16-17

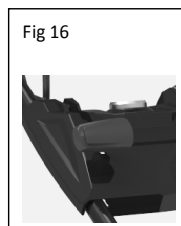

1. When starting a cold engine, Need to **choke lever is at the rabbit position.**



before starting

2. Stand behind the mower . Pull the engine  
Start/stop lever toward upper handle  
With one hand . And Place the other hand  
On the starter handle.
3. Pull the starter handle out approx.. 10-15cm  
Until you feel a resistance and then start the  
Engine with a sharp pull .

**NOTE** : If the engine fails to start after  
three pulls, repeat the process .

4. Once the engine is running, put the starter rope  
Into the rope guide .As shown in Fig 18

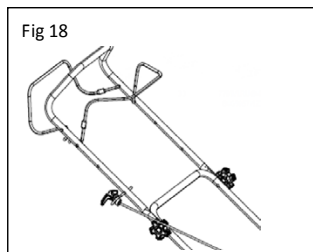

## To stop the engine

As shown in Fig 19

Release the engine start/stop lever, it will return to its Initial position, the engine will automatically switches off.

Fig 19

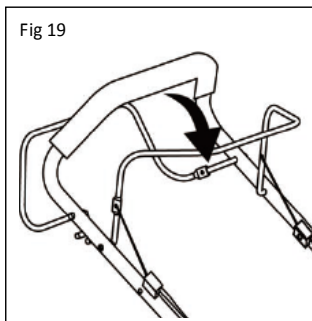

## Lithium starting operation and precautions guide

### 1. Battery charge



- Plug the charger input wire into the power socket and the power indicator light is on (green)
- Plug the battery into the charger slot and put it in place. When the battery is charging, the charging indicator light is on (red), and the green indicator light goes out.
- When the battery is fully charged, the red indicator light goes out, the green indicator light is on.
- Remove the battery and remove the charger input line from the socket.

### 2. Install the battery.



- a. Open the battery case
- b. Insert the battery into the slot and push it in place
- c. Close the battery compartment cover.

### 3. Startup operation



- a. First of all, check the machine and add fuel and lubricating oil
- b. Pull the flameout rod in place and press the start button. When the gasoline engine starts, release the start button.

### 4. Take out the battery



- a. Open the battery compartment, press the battery button,
- b. Take out the battery, release the battery buckle and close the battery compartment.

### 5. Install the control panel

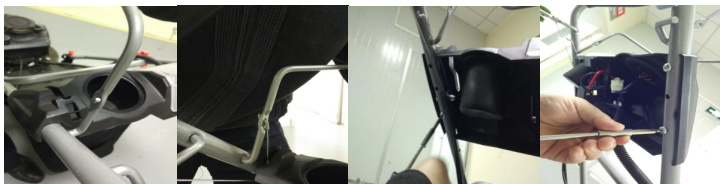

- a. Put the panel on the push rod and fit the mounting hole
- b. Pull the wire through the slot in the panel then attach the wire to the push rod;
- c. Fix the panel on the upper push rod with screws.



## 6. Long handle height adjustment



- Rotate the quick adjusting knob 90° on both sides of the lower push rod;
- Adjust the push rod to the correct height;
- Return the quick adjustment knob to its original angle

## 7. Machine handstand placement.



- Rotate the quick adjusting knob 90° on both sides of the lower push rod;
- Fold the lower push rod forward so that it is parallel to the lawnmower tray
- Put the handstand machine against the wall.

## Lithium-ion battery and charger parameters and precaution guide

Lithium-ion battery

Parameters: DC12V 2000mAh

### 1. Precaution guide

--State as delivered: Battery pack charging to approximately 40% charge state, Open circuit voltage 10.8V~11.5V.

--Activation: Activate every three months, Activate with charger and machine (charge-discharge-charge) .

--Storage and transportation: If the battery pack is stored for more than three months, Battery packs should be at low temperature, in a dry place; The transportation process should prevent violent vibration, impact, sun and rain, etc.

--When the battery is not in use, please remove it from the device;

--Keep the battery clean and dry;

--The two cell battery can perform better when used at room temperature;

-- If there is stain on the surface of the battery, wipe it with a dry clean cloth;

-- After a long storage period, the battery needs to be activated several times to ensure the maximum efficiency;

-- When dealing with the secondary battery, please separate it from other electrochemical systems products

-- The waste battery should be disposed of by the relevant disposing unit

## 2. Safety

The improper use of lithium ion battery can cause battery damage and even endanger personal safety. Please read carefully, use correctly and take precautions:

Electrical performance abuse

-- Charge and use according to specifications;

-- Use Lithium - ion specific charger;

-- Ensure that the polarity is correct when charging, The battery cannot be charged on the back side;

-- Do not plug in the battery on the charger when it is not in use

Environmental abuse

- Do not put the battery on fire, and do not put the battery into water.
- Do not place the battery core under the direct sunlight, which may cause the core to produce heat, smoke, fire, and can also cause bad performance and shorten the service life;
- The battery cannot be dismantled, opened, and decomposed without permission. It can only be dismantled by professionals. The enclosure must be designed so that professionals can only use tools to disassemble it;
- Do not leave the battery in a hostile environment: extreme temperature, deep cycle, overcharge or over discharge;
- Do not short-circuit the battery, it would permanently damage it;
- The battery cannot bear mechanical shock;
- Do not burn or damage the battery, which may lead to toxic gases release or explosion.

**3.  Warning**

- When using a new battery or a battery that was stored for a long time, please charge the battery before using it;
- The reverse charge is forbidden, correctly connect the positive and negative polarity of the battery. If the positive and negative polarity cannot charge the core, the reverse charge will reduce the charging and discharging performance and safety of the battery core, and will cause high temperature and electric leakage.
- Do not mix old and new batteries or different types of batteries, this may cause over discharge.
- If there is abnormal noise, abnormal temperature or leakage, please stop using immediately.
- If the battery is hot, do not touch it until it has cooled down;
- Do not remove the shell of the battery;
- If the battery is hot after used, please cool in a ventilated environment before recharging;
- Do not try to separate, squeeze, hit the battery. Otherwise, the battery will heat

or catch fire and the lye in the battery will be harmful to the skin and eyes, and will damage the clothing.

- Keep the battery away from children. If swallowed, contact your doctor immediately
- When the battery leaks, your skin and eyes cannot touch the liquid. Once touched, immediately flush the injured area with a large amount of water and immediately see a doctor.

### **Lithium ion battery charger**

Parameters: Input AC100~120V 50~60Hz, output DC12.6V-1.5A



#### **Precaution guide.**

- Please use according to the specification,
- Please note that wrong usage may lead to electrical conduction, smoking, glow, damage .
- When using, the input voltage/temperature range must conform to the specification, otherwise it can cause damage.
- Do not place in high temperature/high humidity/dust/corrosion environment,
- It is strictly forbidden to cover during power up, otherwise it can cause damage/deformation/scald, etc,
- When the battery is fully charged, please remove it from the charger and remove the charger input line from the power socket,
- Under the stipulated storage conditions, if the storage time is superior to 6 months, it will need to charge at least 2 hours, otherwise, it may shorten the service life.

### **To clean a flooded engine**



**NOTE:** if the engine won't start after you have Operated the starter several times , the engine may be flood with excess fuel . Use following procedure to clear and start a flooded engine.

1. Release the engine start/stop lever to stop engine.

2. Remove the spark plug, dry it, and then reinstall it.



**NOTE:** Install the spark plug carefully by hand, to avoid cross-threading. After the plug is seated tighten 1/8 to 1/4 turn with socket spanner of spark plug to compress the washer.

3. Pull the engine start/stop lever toward upper handle.
4. Operate the starter as described above.

### Using the Self-propelled function

As shown in Fig 21

This unit equipped with self-propelled system .

If you press the drive lever(clutch lever) , the clutch for the drive will be closed and the lawnmower will start to move with the engine running .

To stop the moving lawnmower , just simply release the drive lever in good time .

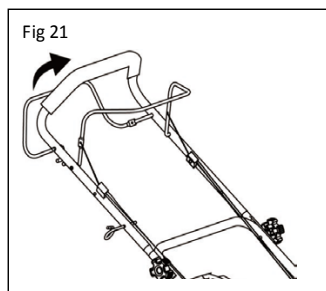

### Mowing



**WARNING:** Always observe the strictest safety procedures when using the lawnmower. Carefully read the safety instructions of this manual before using the lawnmower.



**WARNING:** Never open the ejector flap when the grass bag has been detached (to be emptied) and the engine is still running. The rotating blade can cause serious injuries!

1. Select your required setting.
2. Start the engine and allow it run, and set it to required speed.  
See "to start the engine".
3. Keep a firm grip on the upper handle with engine stop/start lever and drive lever (clutch lever) closed and walk along with it self-propelling to start mowing.

---

## Working advices

1. Walk, never run with the mower, be very careful when mowing uneven or rough ground.
2. Mow across slopes, never up and down.
3. Be careful when changing the direction of the mower on a slope.
4. Do not mow excessively steep slopes.
5. The best result will be achieved if the grass is dry. Wet grass will tend to clog the blade and the grass collection system.
6. Grass grows at different rates at different time of the year. Never use the lowest cutting height for the first cut of the season or in drought conditions.
7. Only about one thirds of the grass height should be cut.
8. When mowing with mulching, to ensure that the cut grass can be scattered efficiently, do not cut high or wet grass. When you have been cutting for several minutes, please stop the mower, and clean the blade and the deck.
9. Do not remove grass debris in the mower casing or on the blade by hand or with your feet. Instead use suitable tools such as a brush or broom.

## Emptying the grass bag

As soon as grass clippings start to trail the lawn mower, it is time to empty the grass bag.



**NOTE:** Before taking off the grass bag, switch off the engine and wait until the blade has come to a stop.

1. To take off the grass bag, use one hand to lift up ejector flap and the other to grab onto the carry handle. The ejector flap automatically falls down after removing the grass bag and closes off the rear chute opening.
2. Empty the grass debris in the grass bag, and refit grass Bag.



**NOTE:** If any grass residue is caught in the discharge chute, clean it using a brush .Do not remove grass debris in the mower casing or On the blade by hand or with your feet. Instead use suitable tools such as a brush or broom. To ensure that the cut grass can be collected into grass Bag, the discharge opening and inside the mower casing must be cleared of any blockage.

## STORING AND MAINTENANCE

---



**WARNING :** Before performing any maintenance or cleaning work, switch Off the engine and wait until the blade has come to a stop.

## Cleaning

### General cleaning

The lawn mower should be cleaned thoroughly every time after it has been used.

Always clean your lawnmower immediately after use.

Do not allow grass cuttings and other debris to become dry and hard on any of the mower surfaces.

Dried grass remnants and dirt may impair the mowing operation.

Check that the grass chute is free of any residual grass. Remove any such residue.

Check the underside of the lawn mower and the blade mount . for this purpose ,tilt the Lawn mower onto its left side (opposite the oil filler neck)



**NOTE :** Before placing the lawn mower on its side , fully drain the fuel tank using a petrol extraction pump.

Do not tilt the lawn mower by more than 90 degrees.

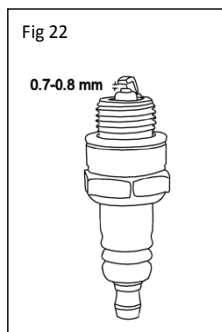

### Maintenance of the spark plug.

As shown in Fig 22

1. Once the engine has cooled , pull off the spark plug with a twist.
2. Remove the spark plug using a spark plug wrench
3. Clean the spark plugh with a wire brush(not supplied).
4. Using a feeler gauge set the gap to 0.75mm
5. Install the spark plug carefully by hand , to avoid cross-threading .
6. After the spark plug is seated , tighten with the spanner to compress the washer.

### How to Service the Air Filter

As shown in Fig 23

Soiled air filters reduce the engine output by supply too little air to the carburetor. if the air contains a lot of dust , the air filter should be checked more frequently .

**⚠ WARNING!** Never run the engine without the air filter element installed.

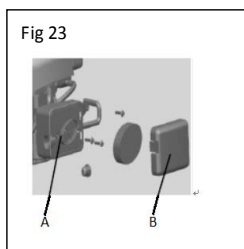

1. Remove the air cleaner outside cover (A).  
Be careful to prevent dirt and debris from falling into the air cleaner assembly.
2. Separate the Air Filter (A) from the Air Filter Housing (B).
3. Inspect the air filter. Clean dirty air filter with warm water and mild soap. Allow air filter to dry thoroughly before re-installation
4. Install the air filter assembly onto the carburetor and secure with screw.

**Note:** Do not use pressurized air or solvents to clean the filter. Pressurized air can damage the filter and solvents will dissolve the filter.

### Changing the engine oil

Tilt the lawnmower towards the oil filler , have a container ready to catch the oil and remove the dipstick . once the oil has been emptied , replace the dipstick and wipe clean any spillages.

Refill with 500ml SAE30 oil or equivalent i. e SAE5W/30, SAE10W/30. When the dipstick is rested on the filler pipe (i. e . not turn in pace ) , the oil level must be between the min and max marks on the dipstick.

See "Checking the engine oil level and filling with engine oil "

Start the engine and allow it to run briefly.

Stop the engine ,wait one minute and check the oil level . top up if necessary .

Note ! see more in engine manual.

### Replacing the blade

For safety reasons you should only ever have your blade sharpened , balanced and mounted by an authorised service workshop. For optimum results it is recommended that the blade should be inspected once a year.

**⚠ WARNING!** Before you remove the grass collection bag, stop the engine and wait until the blade stops completely.

**⚠ WARNING!** You will need garden gloves (not provided) and a spanner wrench(not provided) to remove the blade.

**⚠ NOTE!** Don't invert the mower. Tip it slightly towards the oil filler pipe



and reach under the deck

**⚠ WARNING!** Always handle the blade with care, sharp edges could cause injury **USE GLOVES**. Renew your metal blade after 50Hrs mowing or 2yrs whichever is sooner regardless of condition.

**⚠ WARNING!** If the blade is cracked or damaged replace it with a new one.

**⚠ WARNING!** Don't hold the blade by hand directly.

**⚠ NOTE!** Maintain the sharpness of the blade when cutting grass. If the blade has worn excessively and become pitted and blunt, it should be replaced or sharpened. The sharpness of the blade will affect the performance of the lawnmower.

For safety reasons we recommend that the blade only be changed by someone qualified and authorized to do so.

Hold the blade and unscrew the blade bolt counterclockwise using a spanner wrench. Remove the washer and the blade.

Fit a new blade or re-sharpen the blade, locate the blade on the two studs on the blade flange and then replace the washer and bolts. Make sure the blade is correctly located, and then firmly tighten the bolt (37 Nm). Do not over tighten. The upturn of the blade must project into the motor compartment.

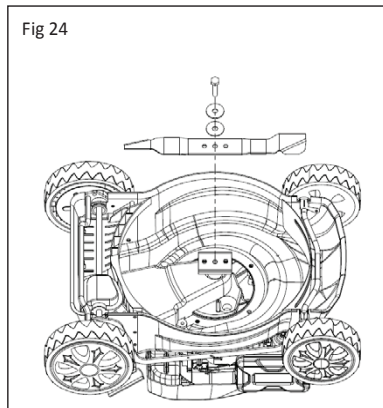

### Storing the Lawnmower for Short Periods

The lawnmower can be stored for short periods of time (less than 15 days) without performing any storage maintenance. Before placing the lawnmower into storage always carry out the following:

1. Allow the engine to fully cool.
2. Ensure the grass bag is empty.
3. Clean all debris from under the mower deck.
4. Store the lawnmower on flat and level surface with the mower upright.
5. Store in a safe place which is not accessible by children or people who are not familiar with operation.

## Storing the Lawnmower for Extended Periods

If the lawnmower is to be placed into storage for more than 15 days, storage maintenance must be performed on the lawnmower. If the following steps are not carried out, when you next operate the lawnmower it may not start correctly and may need to be serviced.



**CAUTION!** Do not empty the petrol tank in enclosed areas, near fire or when smoking. Petrol fumes can cause explosions and fire

1. Empty the petrol tank with a petrol suction pump if available.
2. Start the engine and let it run until any remaining petrol has been used up.
3. Change the oil at the end of every season. To do so, remove the used engine oil from a warm engine and refill with fresh oil
4. Clean the cooling fins of the cylinder and the housing
5. Be sure to clean the entire machine to protect the paint.
6. Store the machine in a well-ventilated place.

## Maintenance Schedule

Performing routine maintenance correctly on your lawnmower will ensure you get years of trouble free use.

Please keep this manual safe for future reference.

It is recommended that the following maintenance schedule is adhered to. This will ensure the lawn-mower operated correctly and is safe to use.

	12hours of use	24hours of use	36hours of use
Air filter	clean	Clean	replace
Spark plug	check	clean	replace
Engine oil	Check	Replace	check

The Engine oil should be changed after the first 8 hours.

## Transport

Empty the petrol tank

Always let the engine run until it has used up the remainder of petrol in the tank.

Empty the engine oil from the warm engine.

Remove the spark plug boot from the spark plug.

Clean the cooling fins of the cylinder and the housing.

Use the original packaging to ship whenever possible.

## TROUBLESHOOTING



**WARNING:** Before performing any maintenance or cleaning work, switch off the engine and wait until the blade has come to a stop.



### Caution!

Improper repairs can result in the product functioning unsafely. This endangers yourself and your environment.

Faults which cannot be rectified with the aid of following table may be rectified by a specialist company only (customer service center).

Please be aware that any improper repairs will also invalidate the warranty and additional costs may be incurred.

Use only genuine spare parts. Only these spare parts are designed and suitable for the product. The use of other spare parts not only voids the warranty, you can also endanger yourself and your environment.

Fault/malfunction	Cause	Remedy
Loud while running , machine vibrates heavily	Screws are loose	Check screws
	Blade fasteners are loose	Check blade fasteners
	Blade is unbalanced	Replace blade
Engine does not start	Start/stop lever not pressed	Press start/stop lever
	Spark plug is defective	Replace spark plug
	Does the cutting blade is worn or damaged ?	Replace it by the customer service center
	Fuel tank is empty	Refill with fuel
	Engine may be flooded	Remove plug and dry
Engine runs unsteadily	Air filter is soiled	Clean the air filter
	Spark plug is soiled	Clean the spark plug
Uneven mowing results	Blade is blunt	Sharpen the blade
	Cutting height is too low	Set correct height
Grass bag is not filled sufficiently	Blade is worn	Replace the blade
	Grass bag is clogged	Empty the grass bag
	Cutting height is right?	Correct the cutting height
	The lawn / grass is wet ?	Allow the lawn to dry
	Does the discharge channel/ housing blocked ?	Clean the discharge channel/ housing
	Does underside of the mower deck have been clogged?	Clean the underside of the mower deck

**DUCAR**