

LITTLE BEAVER

Engine parts manual

Model : DUEZT2460-T5400
Zero-turn mower



Picture may not reflect the exact model

AIR CLEANER

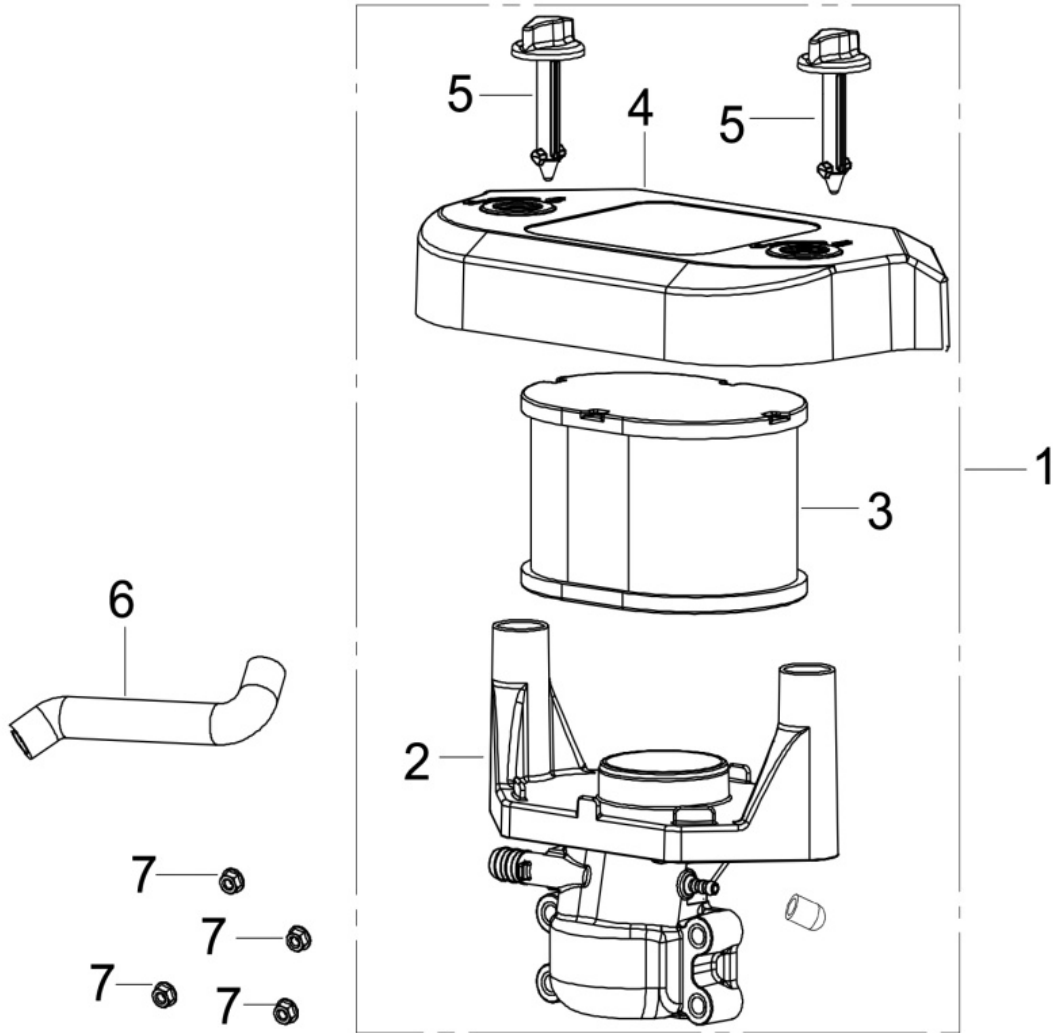

No.	Part number	Description	Qty
1	DUPZT1800101230002	Air filter	1
2	DUPZT1802801180001	Air filter seat	1
3	DUPZT1801001090001	Air filter element combination	1
4	DUPZT1800702550001	Air filter casing cover	1
5	DUPZT1802700110001	Lock bolt for air filter cover	2
6	DUPZT3807406320002	Breather tube	1
7	DUPZT3803700660001	Hexagon nut with flange	4

BLOWER HOUSING

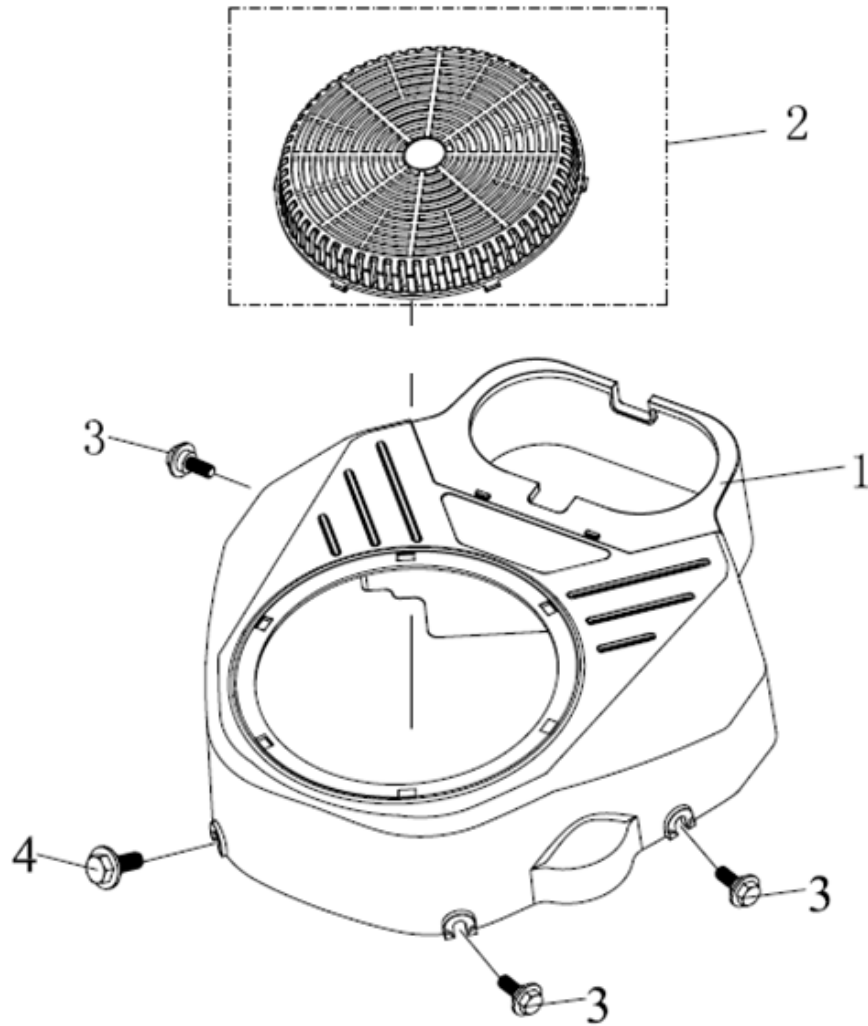

No.	Part number	Description	Qty
1	DUPZT1602100440001	Fan cover comp.	1
2	DUPZT1953600100002	Starter outer cover	1
3	DUPZT3800200860001	Hexagon shaft shoulder bolt	3
4	DUPZT3800200870001	Hexagon shaft shoulder bolt	1

CARBURETOR

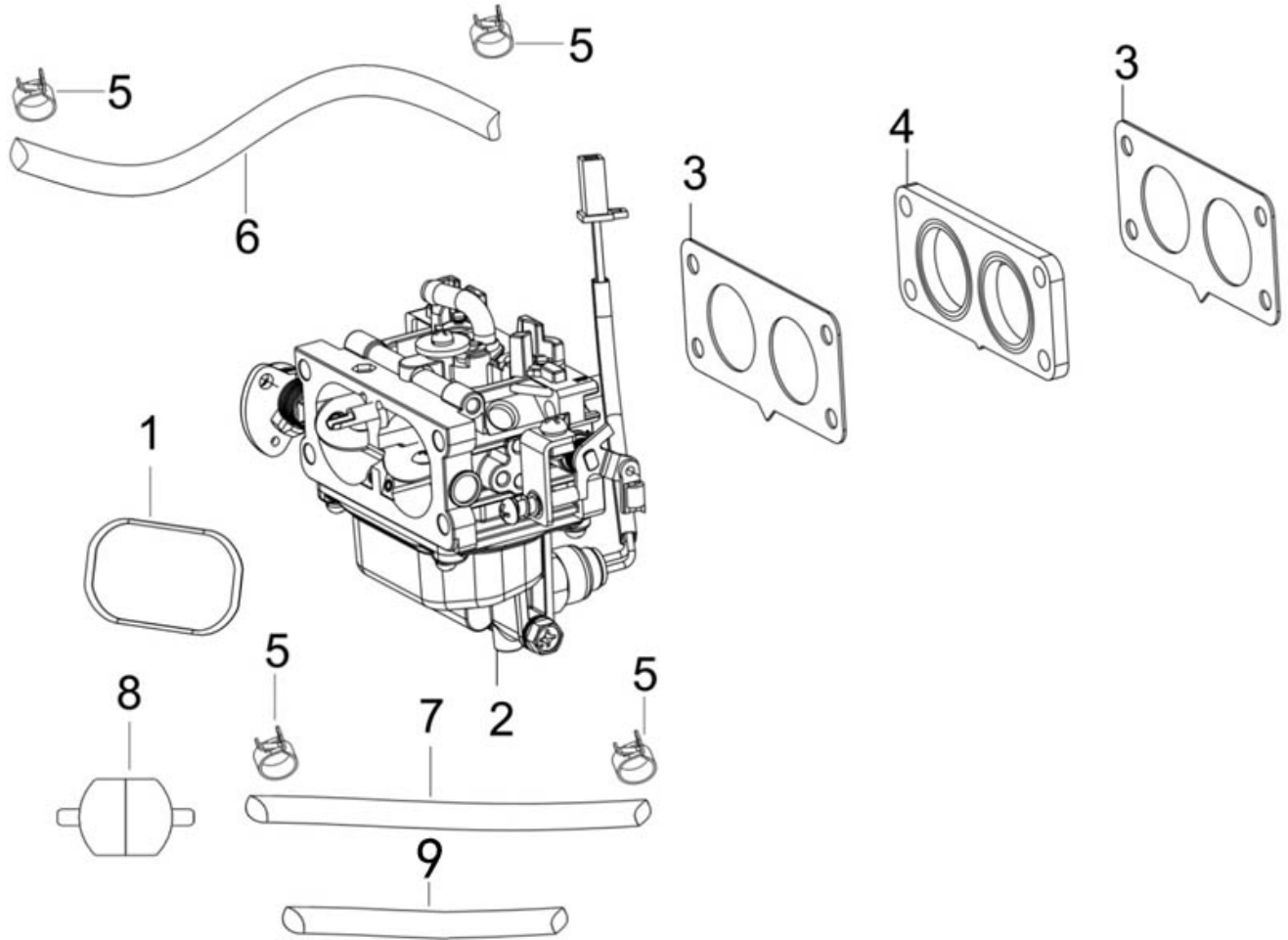

No.	Part number	Description	Qty
1	DUPZT3808410740001	Seal ring	1
2	DUPZT1700224350001	Carburetor	1
3	DUPZT1704301070001	Carburetor gasket	2
4	DUPZT1704400730001	Heat insulating pad for carburetor	1
5	DUPZT3809602870001	Clip combination	4
6	DUPZT3807505960001	Oil tube	1
7	DUPZT3807507420001	Oil tube	1
8	DUPZT1700100450001	Fuel filter	1
9	DUPZT3807703430001	Protective sleeve	1

CRANKCASE COVER

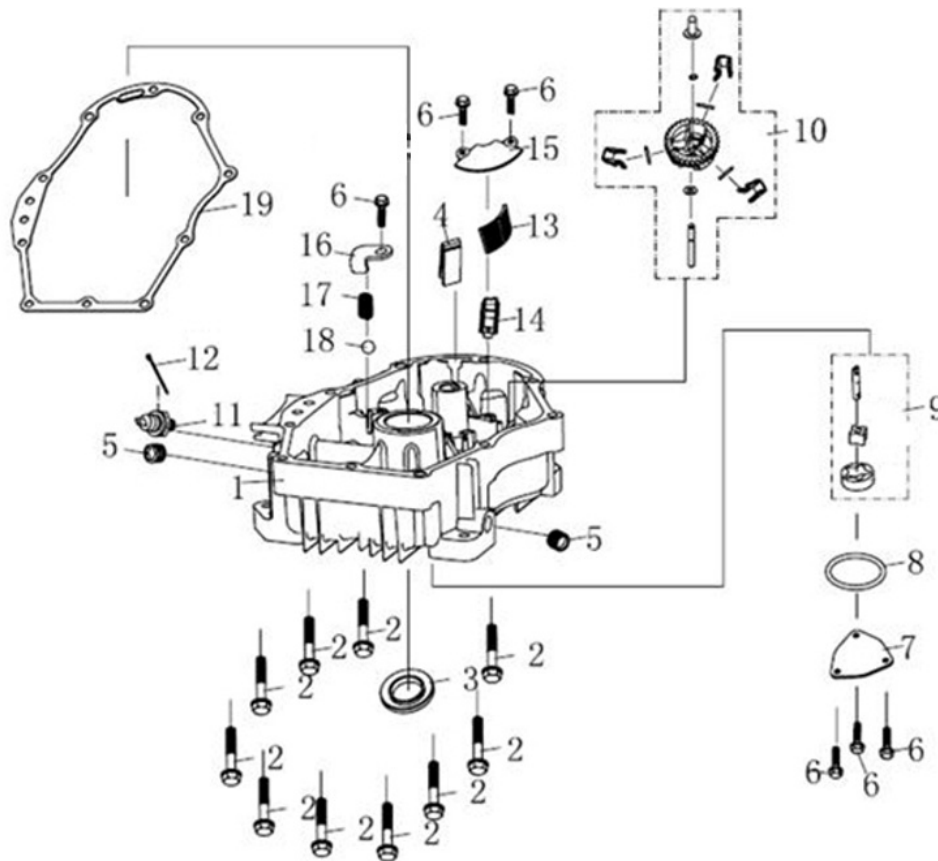

No.	Part number	Description	Qty
1	DUPZT1108201720001	Crankcase cover	1
2	DUPZT3801403380001	Hexagon bolt with flange	10
3	DUPZT3806507700001	Oil seal	1
4	DUPZT1505700030001	Engine oil return block	1
5	DUPZT1102600880002	Sealing plug screw	2
6	DUPZT3801400130005	Hexagon bolt with flange	6
7	DUPZT1500400250001	Oil pump cover	1
8	DUPZT3808411590002	Seal ring	1
9	DUPZT1500100840001	Components of oil pump	1
10	DUPZT1717500530001	Components of governor gear	1
11	DUPZT2836900020001	Oil level alarm	1
12	DUPZT3809000620001	Strap	1
13	DUPZT1502900190001	Engine oil Strainer	1
14	DUPZT1205300050001	Pressing plate for oil groove	1
15	DUPZT1503400120001	Cover,Oil Strainer	1
16	DUPZT1205300060001	Pressing plate for oil groove	1
17	DUPZT3811504370001	Compression spring	1
18	DUPZT3806400160001	Steel ball	1
19	DUPZT1108300340001	Crankcase cover gasket	1

CRANKCASE

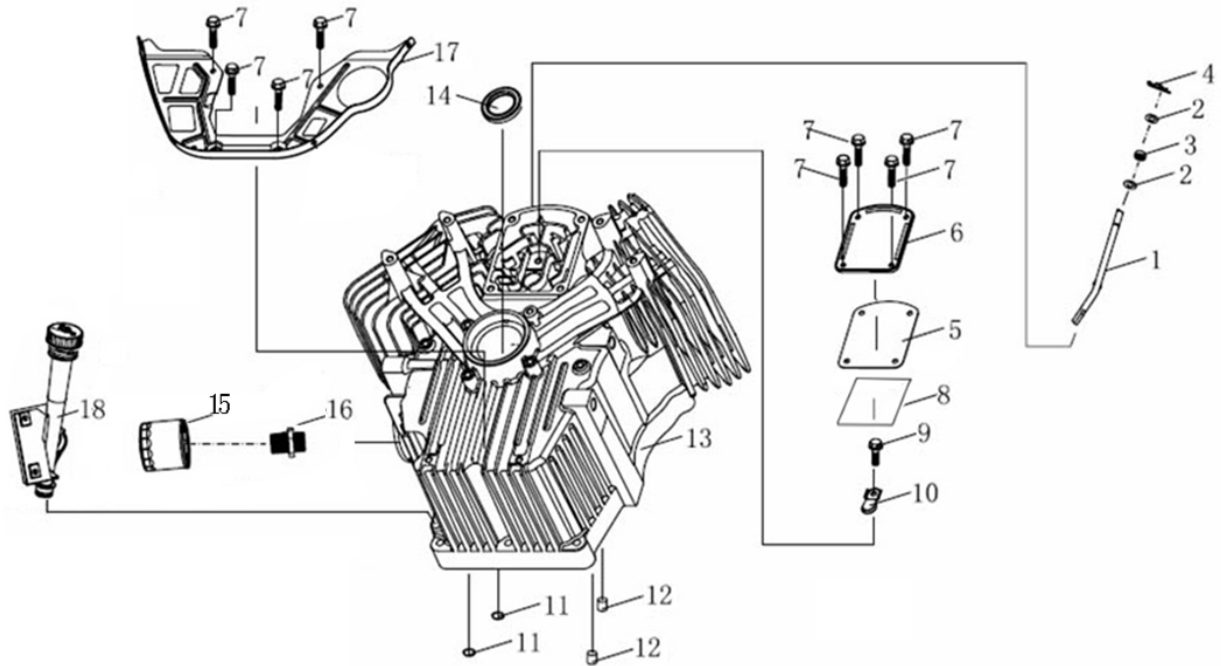

No.	Part number	Description	Qty
1	DUPZT1716300130001	Speed regulating arm	1
2	DUPZT3804505590001	Flat washer	2
3	DUPZT3806503390001	Oil seal	1
4	DUPZT3813500040001	Pin clip	1
5	DUPZT1108500120001	PACKING, BREATHER CHAMBER	1
6	DUPZT1108400130001	CAP,BREATHER CHAMBER	1
7	DUPZT3801400130005	Hexagon bolt with flange	8
8	DUPZT1745600020001	Filter block	1
9	DUPZT3801400670003	Hexagon bolt with flange	1
10	DUPZT1402500080001	Leaf valve	1
11	DUPZT3808404430001	Seal ring	2
12	DUPZT3806001230001	ocation pin	2
13	DUPZT1108101240001	Crankcase body	1
14	DUPZT3806503370001	Oil seal	1
15	DUPZT1503500460002	Oil filter	1
16	DUPZT1508400020002	Oil filter Mounting bolts	1
17	DUPZT1602000610001	Side plate	1
18	DUPZT1106900430001	Oil rule combination	1

CRANKSHAFT/PISTON

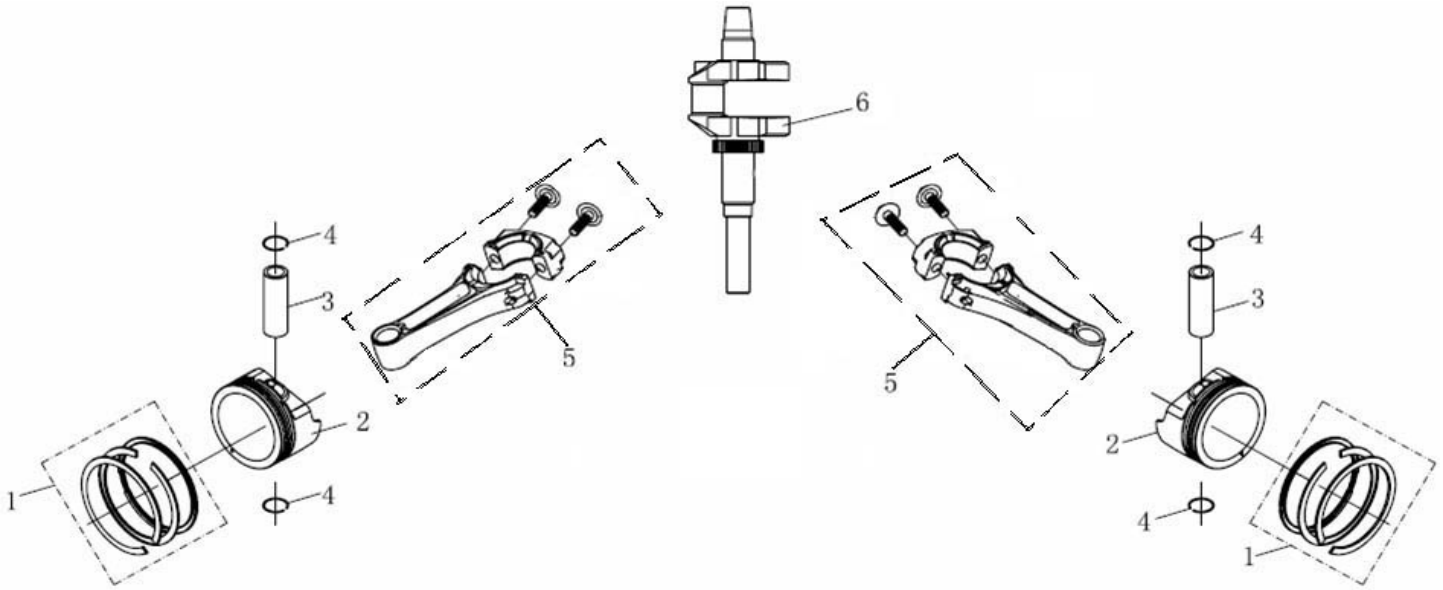

No.	Part number	Description	Qty
1	DUPZT1300701860001	Piston ring combination	2
2	DUPZT1300302270001	Piston	2
3	DUPZT1300600540001	Piston pin	2
4	DUPZT3805600780001	Steel cable baffle ring	4
5	DUPZT1301500730001	Connecting rod	2
6	DUPZT1302904600001	crankshaft	1

CYLINDER HEAD

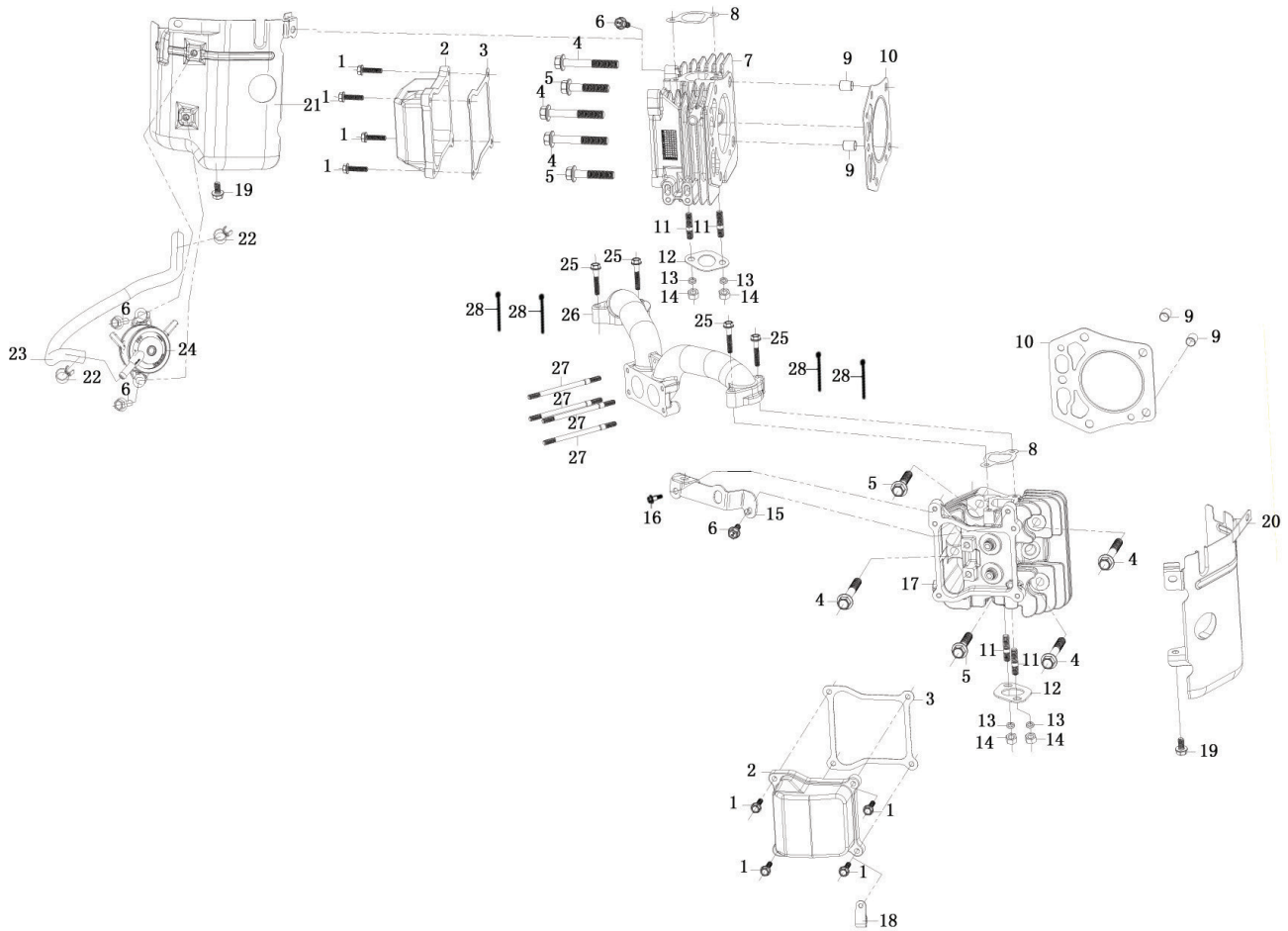

No.	Part number	Description	Qty
1	DUPZT3801401030004	Hexagon bolt with flange	8
2	DUPZT1202200250001	Cylinder head cover assy	2
3	DUPZT1202500610001	Gasket for cylinder head cover	2
4	DUPZT3801404550001	Hexagon bolt with flange	6
5	DUPZT3801404560001	Hexagon bolt with flange	4
6	DUPZT3801400130005	Hexagon bolt with flange	4
7	DUPZT1200807430001	Cylinder head	1
8	DUPZT1704301060001	Carburetor gasket	2
9	DUPZT3806001290001	ocation pin	4
10	DUPZT1201502900001	Gasket for cylinder head	2
11	DUPZT3801801090001	Stud	4
12	DUPZT1806500740001	Outlet gasket	2
13	DUPZT3804600010006	Elastic washer	4
14	DUPZT3803400050005	Hexagon nut	4
15	DUPZT1205500030001	Lifting eye	1
16	DUPZT3800200860001	Hexagon shaft shoulder bolt	1
17	DUPZT1200807410001	Cylinder head	1
18	DUPZT3809404610001	Cable cleat	1

CYLINDER HEAD

No.	Part number	Description	Qty
19	DUPZT3801400670003	Hexagon bolt with flange	2
20	DUPZT1601900360001	air deflector	1
21	DUPZT1601902300001	air deflector	1
22	DUPZT3809601200004	Clip combination	2
23	DUPZT3807411640001	Breather tube	1
24	DUPZT1704600250001	Gasoline pump	1
25	DUPZT3801401000003	Hexagon bolt with flange	4
26	DUPZT1804206340001	Intake pipe	1
27	DUPZT3801801160001	Stud	4
28	DUPZT3809000610002	Strap	4

FLYWHEEL/COIL ASSEMBLY

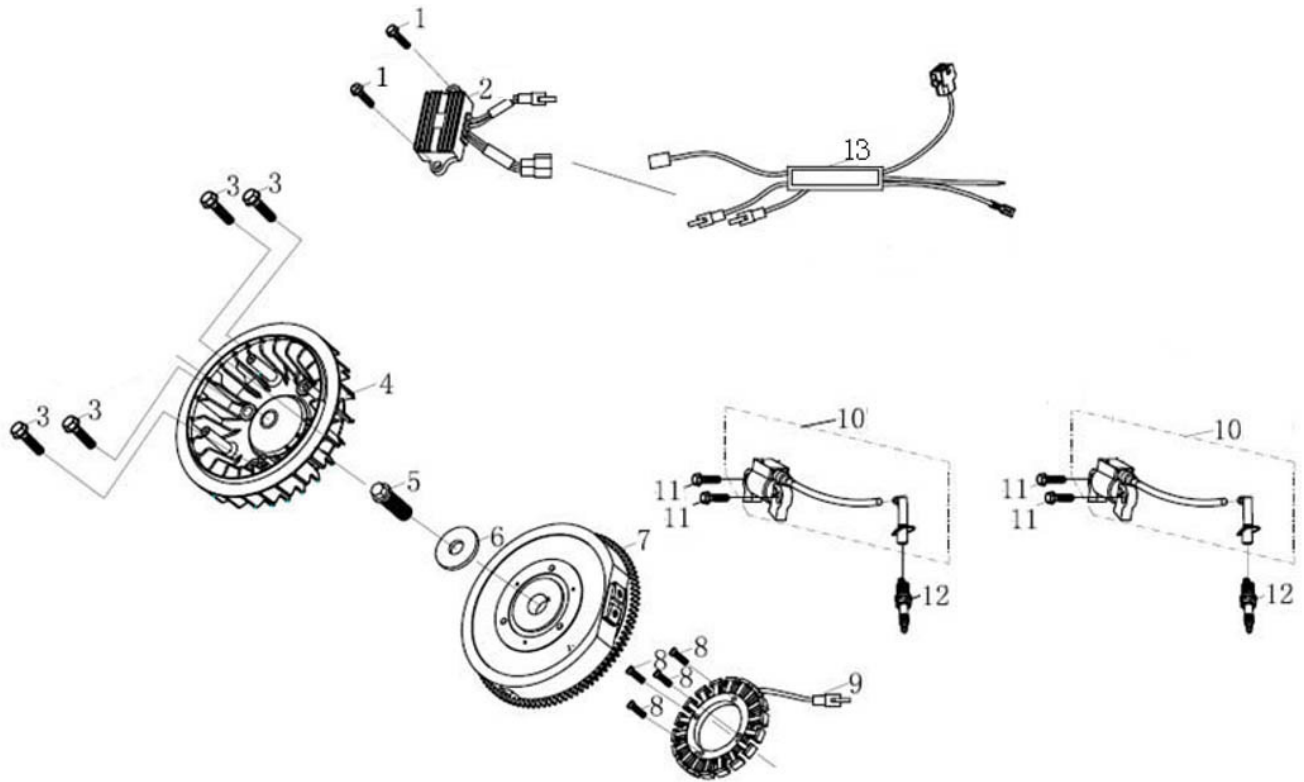

No.	Part number	Description	Qty
1	DUPZT3801400130005	Hexagon bolt with flange	2
2	DUPZT2719300210001	Rectifier	1
3	DUPZT3801404510001	Hexagon bolt with flange	4
4	DUPZT1601800200001	Impeller	1
5	DUPZT3801404570001	Hexagon bolt with flange	1
6	DUPZT3804507020001	Flat washer	1
7	DUPZT2700207760001	FLYWHEEL COMP	1
8	DUPZT3801900390005	Socket head screw	4
9	DUPZT2701900540001	Components of charging current armature	1
10	DUPZT2709203540002	COIL ASSY.,IGNNTION	2
11	DUPZT3801400770005	Hexagon bolt with flange	4
12	DUPZT2709600460001	Spark plug	2
13	DUPZT2712801330001	Connecting wire	1

GOVERNOR

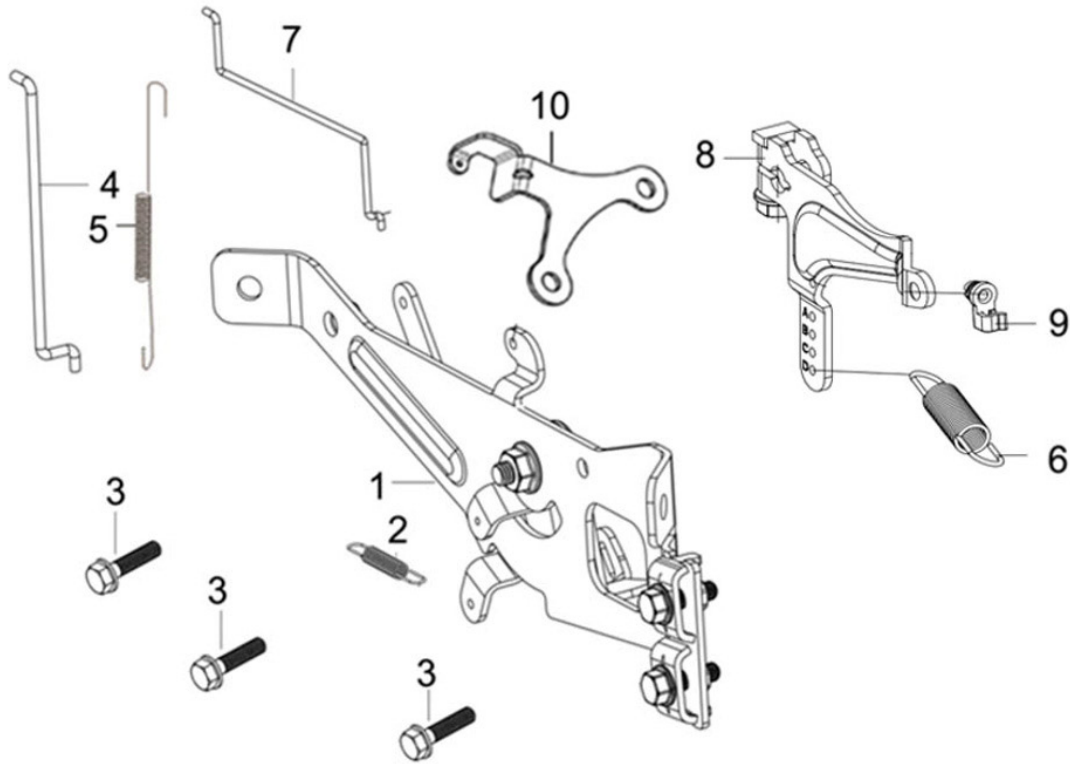

No.	Part number	Description	Qty
1	DUPZT1716801440001	Throttle handle combination	1
2	DUPZT1716100280001	throttle return spring	1
3	DUPZT3801400130005	Hexagon bolt with flange	3
4	DUPZT1715900400001	Throttle rod	1
5	DUPZT1716100480001	throttle return spring	1
6	DUPZT1716001110001	Governing spring	1
7	DUPZT1716500360001	Choke valve pull rod	1
8	DUPZT1716200680001	Speed regulating bracket	1
9	DUPZT1730900030001	Locker of choke valve pull rob	1
10	DUPZT1754000030001	Idle speed adjustment bracket	1

STARTING MOTOR

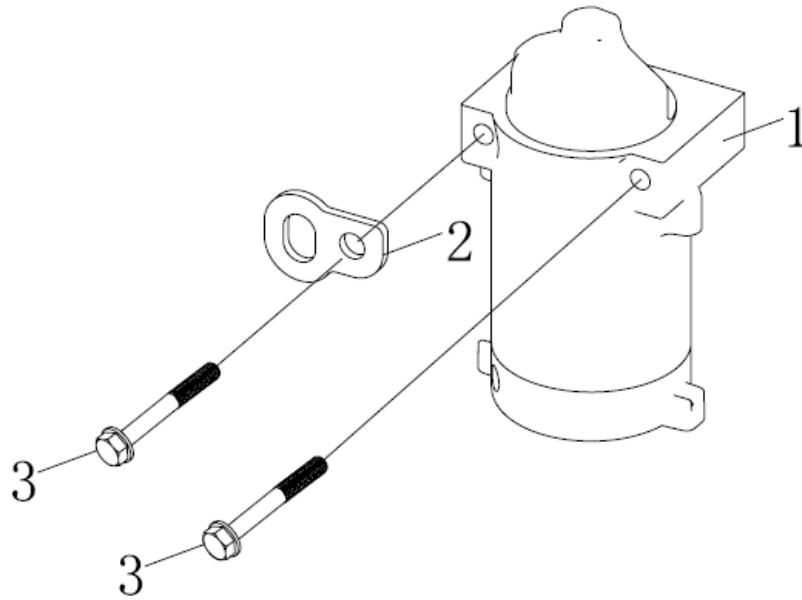

No.	Part number	Description	Qty
1	DUPZT2703601700001	Components of starting motor	1
2	DUPZT1205500020001	Lifting eye	1
3	DUPZT3801404530001	Hexagon bolt with flange	2

VALVE

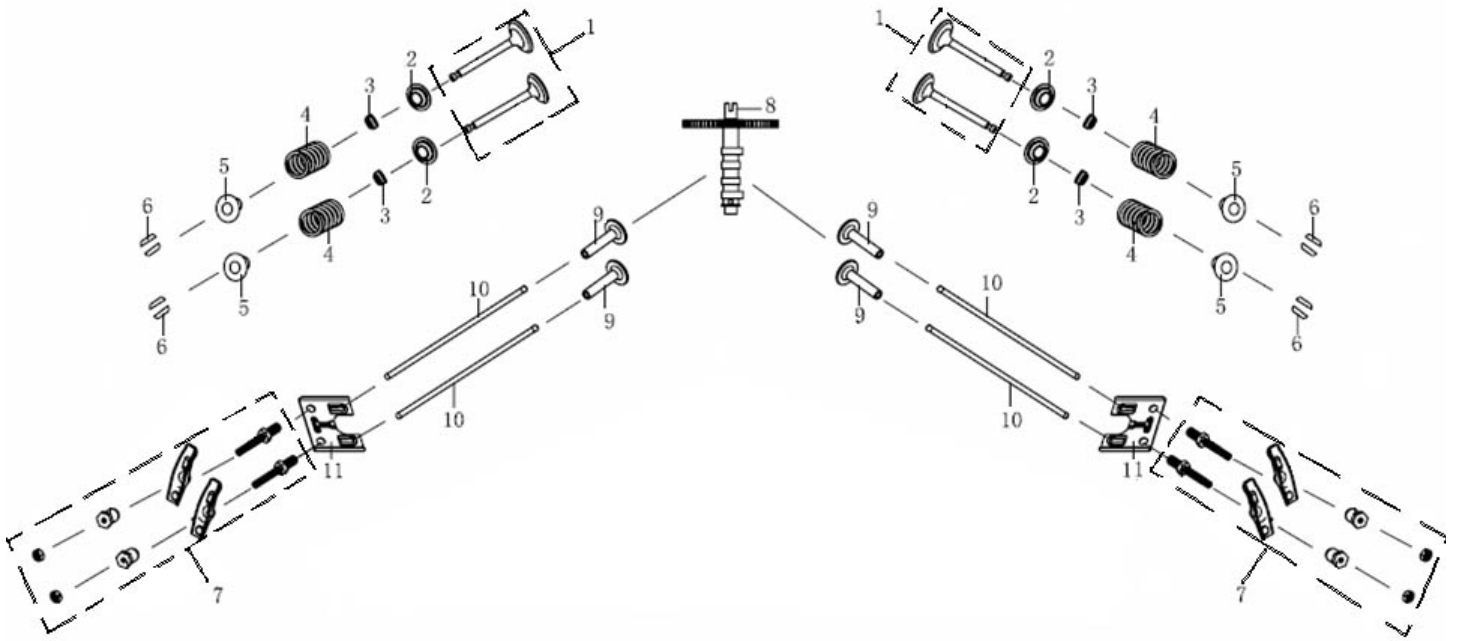

No.	Part number	Description	Qty
1	DUPZT5005500370001	Valve Kit	2
2	DUPZT1403600100001	Seat, valve spring	4
3	DUPZT1404000120001	Valve oil seal	4
4	DUPZT1403400250001	Inner spring of valve	4
5	DUPZT1403800210001	Retainer, valve spring	4
6	DUPZT1403900150001	Valve locker	8
7	DUPZT1404500620001	Valve rocker combination	4
8	DUPZT1400201300001	Camshaft assy	1
9	DUPZT1406900170001	Lifter, Valve	4
10	DUPZT1406700370001	Push rod	4
11	DUPZT1407100140001	Plate, push rod guide	2

MUFFLER ASSEMBLY

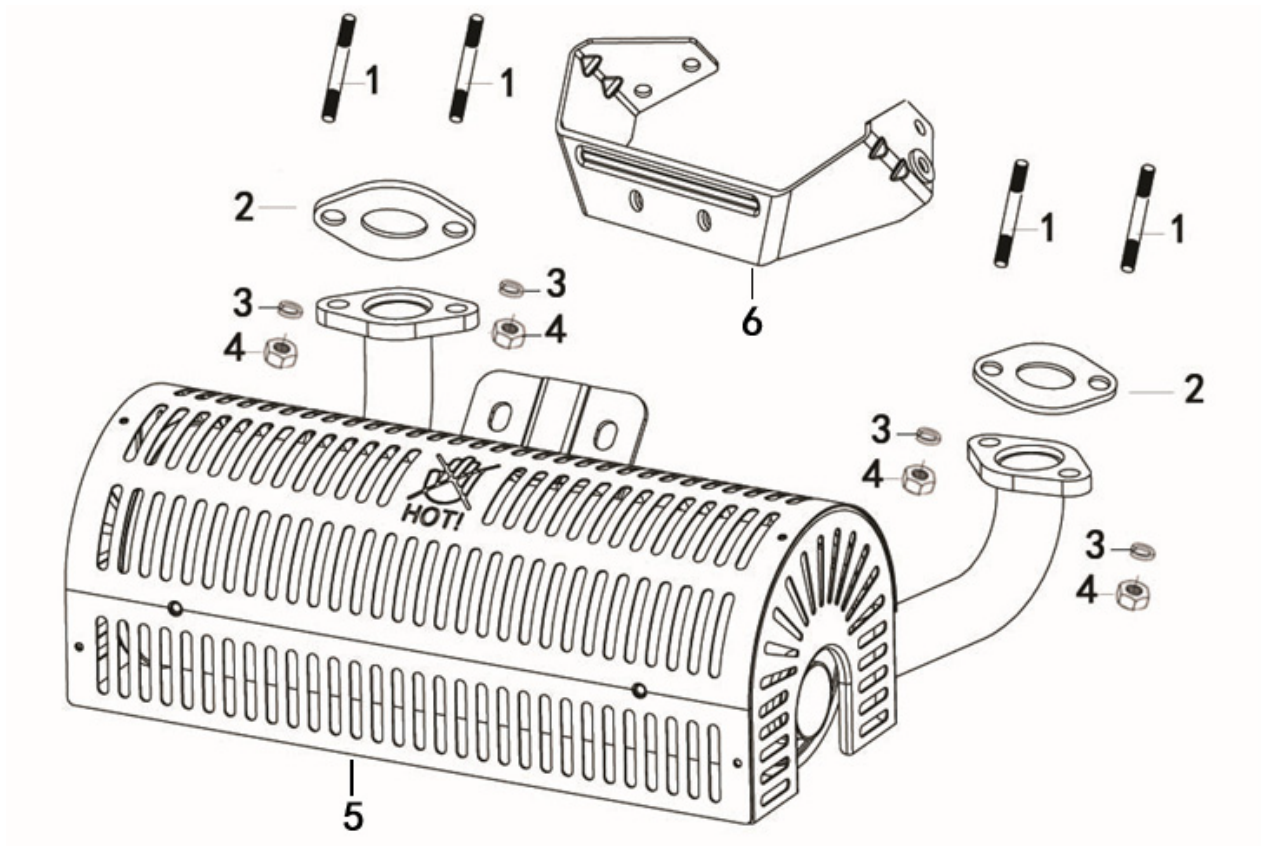

No.	Part number	Description	Qty
1	DUPZT3801801090001	Stud	4
2	DUPZT1806500740001	Outlet gasket	2
3	DUPZT3804600010006	Elastic washer	4
4	DUPZT3803400050005	Hexagon nut	4
5	DUPZT1805713140001	Muffler	1
6	DUPZT1809901150001	Muffler bracket	1