

POWERED BY

# DUCAR

PROPULSÉ PAR

## 44" Brush for DCS DUEDCS-BH44



## PARTS MANUAL

# ASSEMBLY

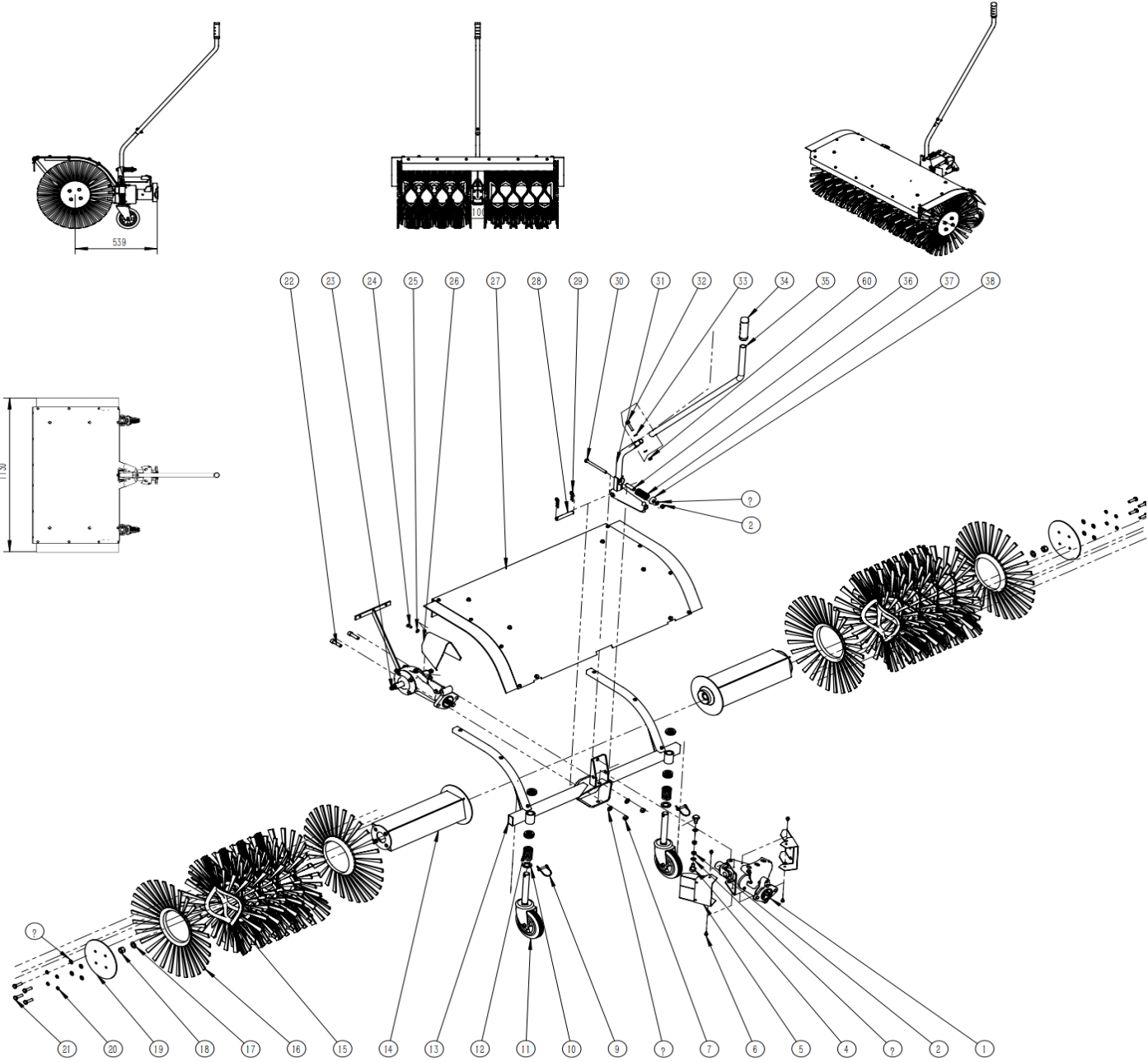

## ASSEMBLY

No.	Product code	Description	Quantity
1	DUPYX7SX-01000000	transmission assembly	1
2	DUPGB/T 6184-2000	all metal hexagaon lock nut	4
3	DUPGB/T 97 .1-2002	flat washer	13
4	DUPYX7SX-01060000	transmission connect base bolt	2
5	DUPYX7SX-05000000	dust shield assembly	2
6	DUPGB/T 5789-1986	hexagon flange bolt	4
7	DUPGB/T 6184-2000	all metal hexagaon lock nut	2
8	DUPGB/T 97 .1-2002	flat washer	2
9	DUPGB/T 119-1986	D bolt	2
10	DUPYX7SX-07030000	universal wheel washer	16
11	DUPYX7SX-07010000	universal wheel	2
12	DUPYX7SX-07040000	universal wheel spring	2
13	DUPYX7SX-02010000	mud shield bracket assembly	1
14	DUPYX7SX-06010000	brush shaft	2
15	DUPYX7SX-06040000	brush	18
16	DUPYX7SX-06030000	brush bowl type	4
17	DUPGB/T 97 .1-2002	flat washer	2
18	DUPGB/T 6185 .1-20	all metal hexagaon lock nut	4
19	DUPYX7SX-06020000	brush out plate	2
20	DUPGB/T 93-1987	standard elastic washer	8
21	DUPGB/T 5783-2000	hexagon bolt full thread	8
22	DUPGB/T 70 .1-2008	Hexagon socket head screws	2
23	DUPYX7SX-04000000	gear box assembly	1
24	DUPGB/T 5783-2000	hexagon bolt full thread	1
25	DUPGB/T 97 .1-2002	flat washer	9
26	DUPYX7SX-04100000	gear box cover assy	1
27	DUPYX7SX-02020000	mud shield assy	1
28	DUPYX7SX-03060000	direction pin	1
29	DUPQC/T 623	B pin	2
30	DUPGB/T 5780-2016	hexagon bolt C class	1
31	DUPYX7SX-03010000	direction base assy	1
32	DUPGB/T 5789-1986	hexagon bolt	1
33	DUPGB/T 955-1987	Corrugated elastic washers	2
34	DUPYX7SX-03030000	direction pin grip	1
35	DUPYX7SX-03020000	direction pole	1
36	DUPYX7SX-03050000	direction pole return sleeve	1
37	DUPYX7SX-03040000	direction pole return spring	1
38	DUPYX7SX-03010700	spring base	2
39	DUPYX7SX-02010500	mud shield support	1
40	DUPYX7SX-04120000	gear box inner spacer	1

# SWEEPER ASSEMBLY

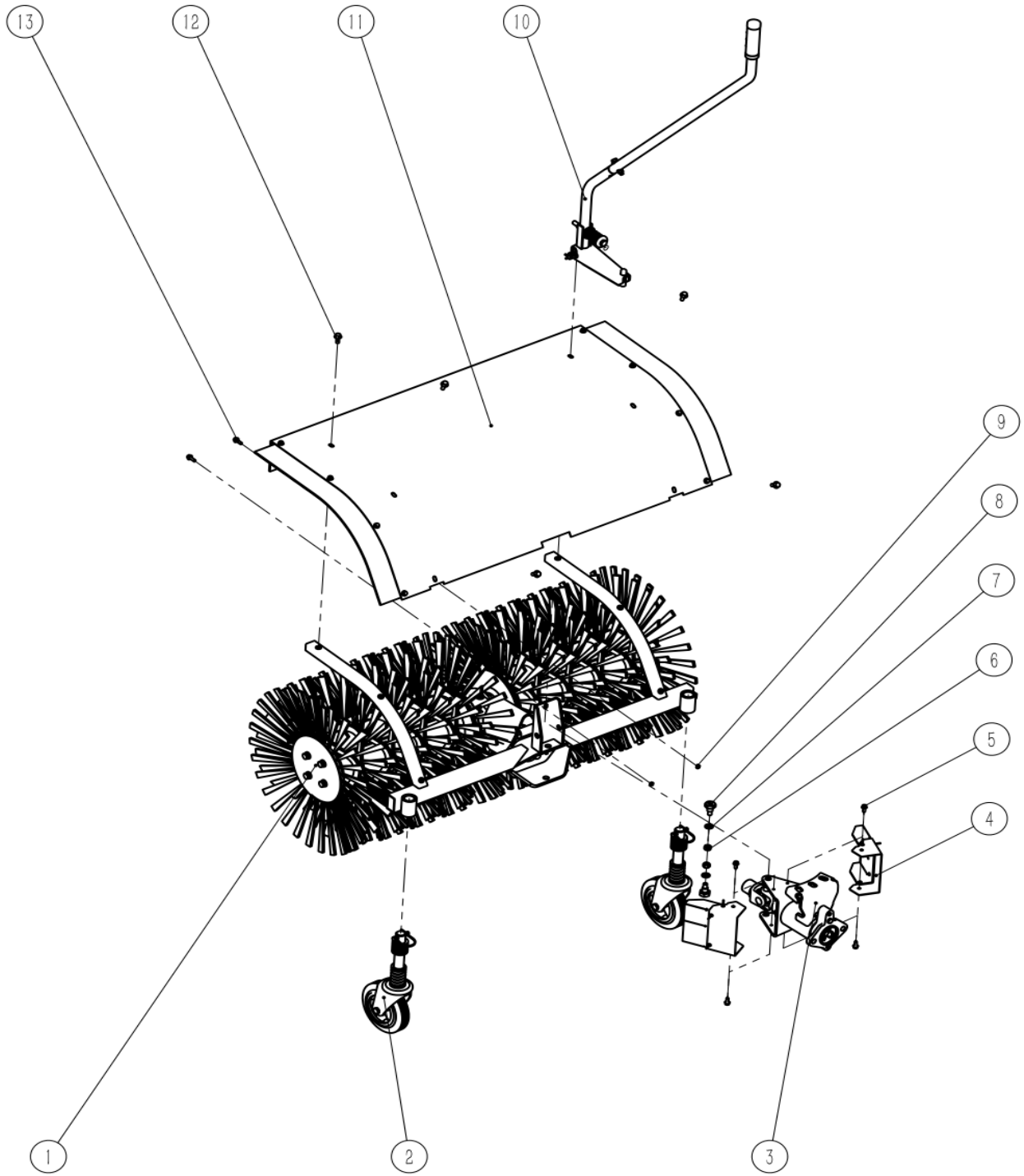

## SWEEPER ASSEMBLY

No.	Product code	Description	Quantity
1	DUPYX7SX-06000000	brush shaft assy	1
2	DUPYX7SX-07000000	universal wheel assy	2
3	DUPYX7SX-01000000	transmission assy	1
4	DUPYX7SX-05000000	dust shield assy	2
5	DUPGB/T 15856.4-20	Hexagon flange cross tapping screws	4
6	DUPGB/T 6184-2000	all metal hexagon lock nut	2
7	DUPGB/T 97.1-2002	10 flat washer	3
8	DUPYX7SX-01060000	transmission connect base fix bolt	2
9	DUPGB/T 6182-2010	Hexagon lock nut with non-metallic insert	2
10	DUPYX7SX-03000000	direction base assy	1
11	DUPYX7SX-02020000	mud shield assy	1
12	DUPGB/T 5789-1986	hexagon flange bot	6
13	DUPGB/T 5789-1986	hexagon flange bot	2

# UNIVERSAL WHEEL

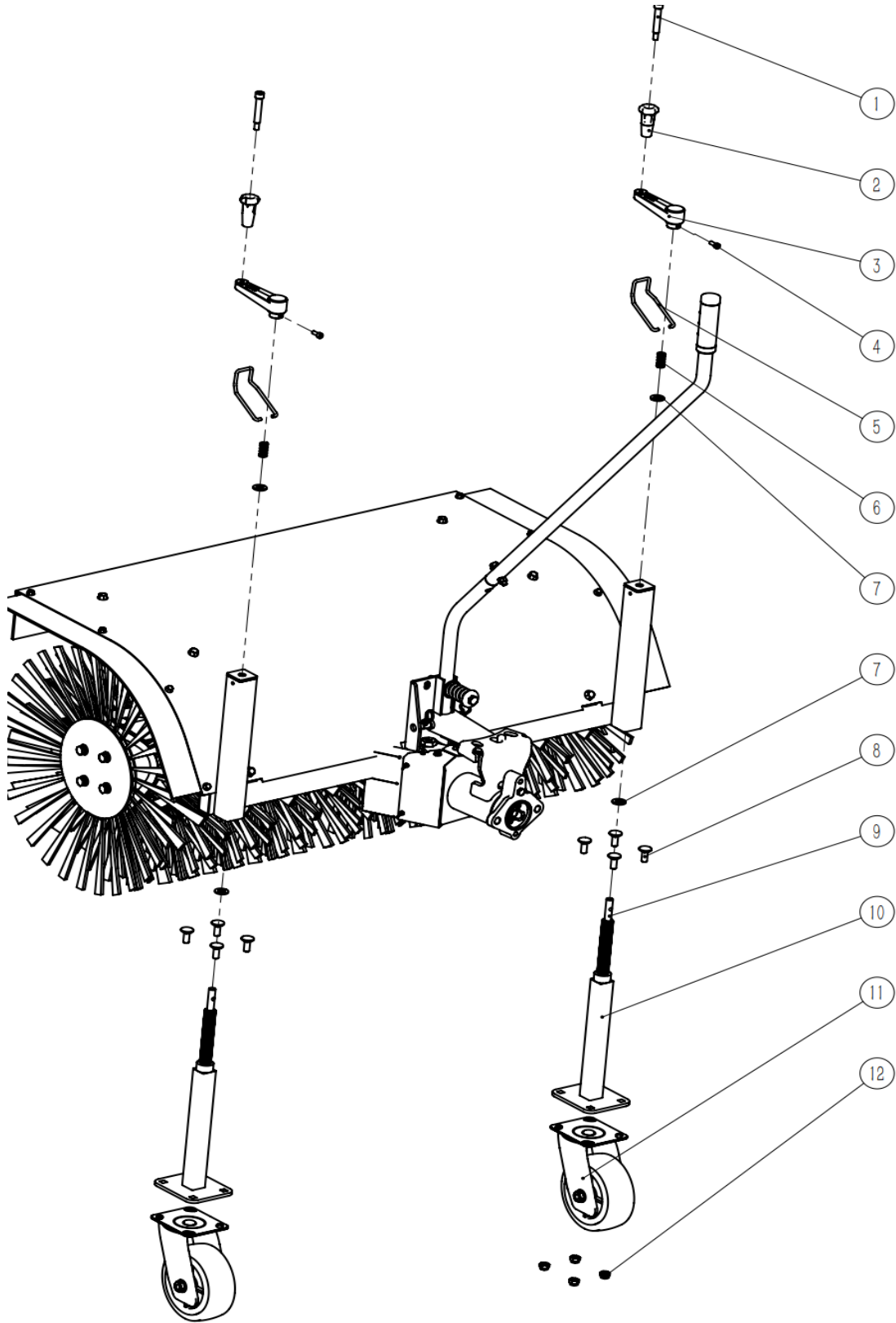

## UNIVERSAL WHEEL

No.	Product code	Description	Quantity
1	DUPYX680-01030000	Z type handle bolt	2
2	DUPYX680-01040000	Z type handlegrip	2
3	DUPYX680-01050000	Z type handle	2
4	DUPGB/T 70.1-2008	Hexagon socket head screws	2
5	DUPYX680-01160000	Z handle latch	2
6	DUPYX730-010704040	iron handle fix spring	2
7	DUPGB/T 97.1-2002	12 flat washer	4
8	DUPGB/T 801-1998	Small semicircle head low square neck bolt	8
9	DUPYX75X-09010000	universal wheel adjust screw	2
10	DUPYX75X-09020000	universal wheel fix square shaft	2
11	DUPYX75X-09030000	heavy duty universal wheel	2
12	DUPGB/T 6182-2010	Hexagon lock nut with non-metallic insert	8

# TRANSMISSION ASSEMBLY

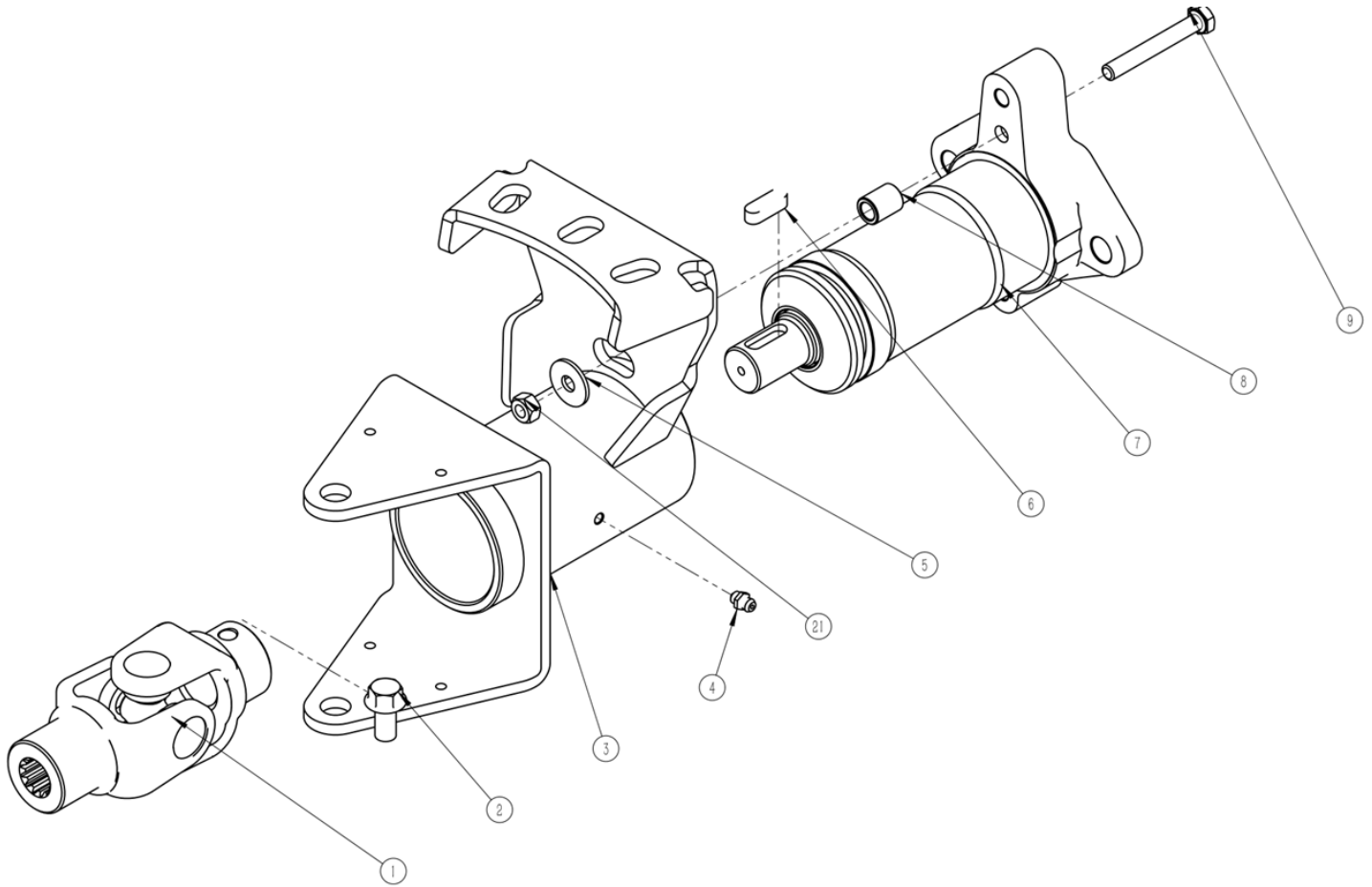

No.	Product code	Description	Quantity
1	DUPYX7SX-01030000	universal joint assy	1
2	DUPGB/T 5789-198	hexagon flange bolt	1
3	DUPYX7SX-01020000	transmission connect base assy	1
4	DUPJB/T 7940.1-199	Straight-through pressure oil cup	1
5	DUPGB/T 96.1-2002	big washer	1
6	DUPGB/T 1096-2003	flat key	1
7	DUPYX7SX-01010000	transmission connect assy	1
8	DUPYX7SX-01040000	transmission connect base limit bushing	1
9	DUPGB/T 5782-2000	hexagon bolt	1

# DIRECTION BASE

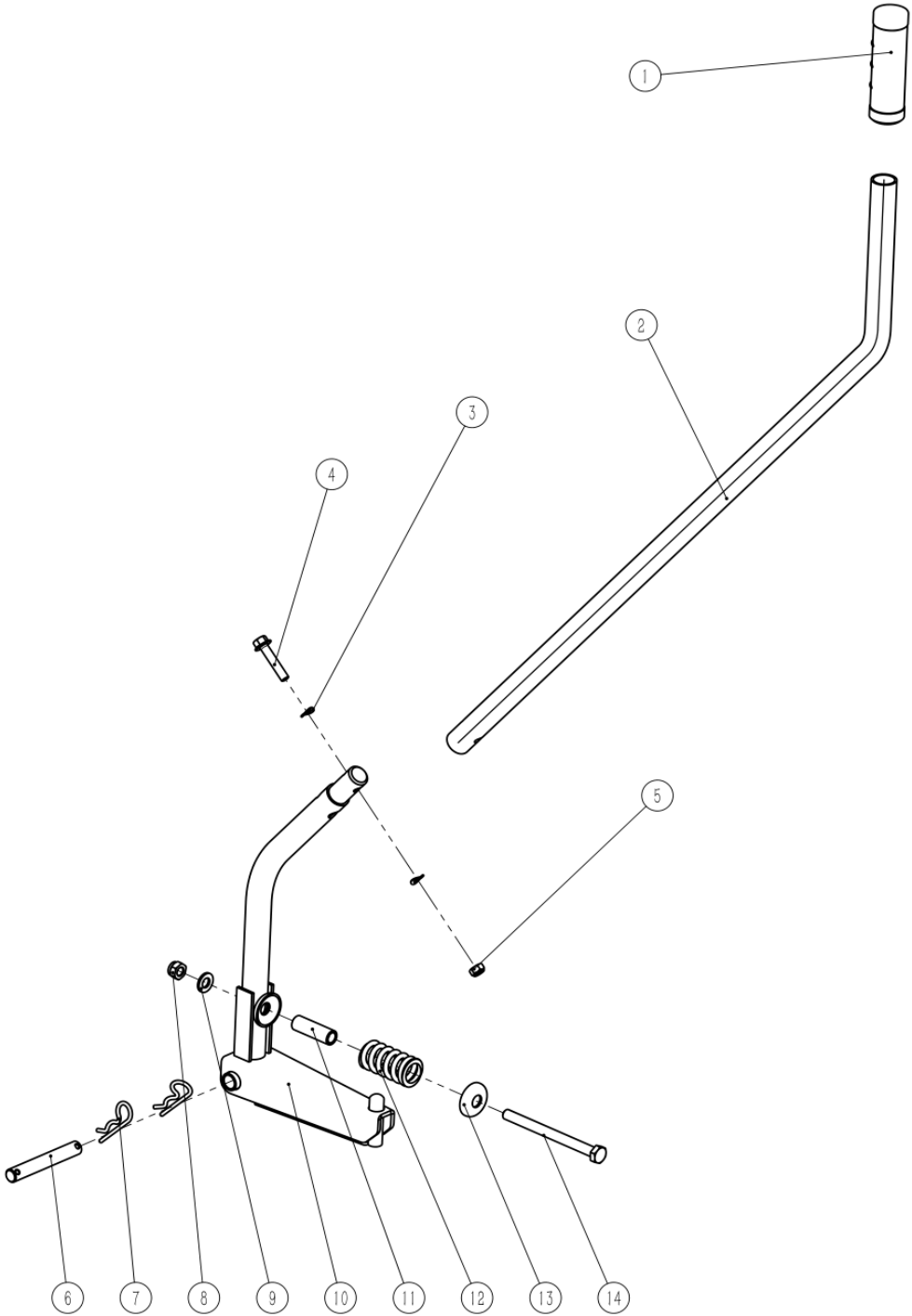

## DIRECTION BASE

No.	Product code	Description	Quantity
1	DUPYX7SX-03030000	direction pin grip	1
2	DUPYX7SX-03020000	direction pin	1
3	DUPGB/T 955-1987	Corrugated elastic washers	2
4	DUPGB/T 5789-1986	hexagon bolt	1
5	DUPGB/T 6182-2010	Hexagon lock nut with non-metallic insert	1
6	DUPYX7SX-03060000	direction pin	1
7	DUPQC/T623	B pin	2
8	DUPGB/T 6182-2010	Hexagon lock nut with non-metallic insert	1
9	DUPGB/T 97.1-2002	10 flat washer	1
10	DUPYX7SX-03010000	direction base assy	1
11	DUPYX7SX-03050000	direction pole return sleeve	1
12	DUPYX7SX-03040000	direction pole return spring	1
13	DUPYX7SX-03010700	spring base	1
14	DUPGB/T 5780-2016	hexagon bolt C class	1

# GEAR BOX ASSEMBLY

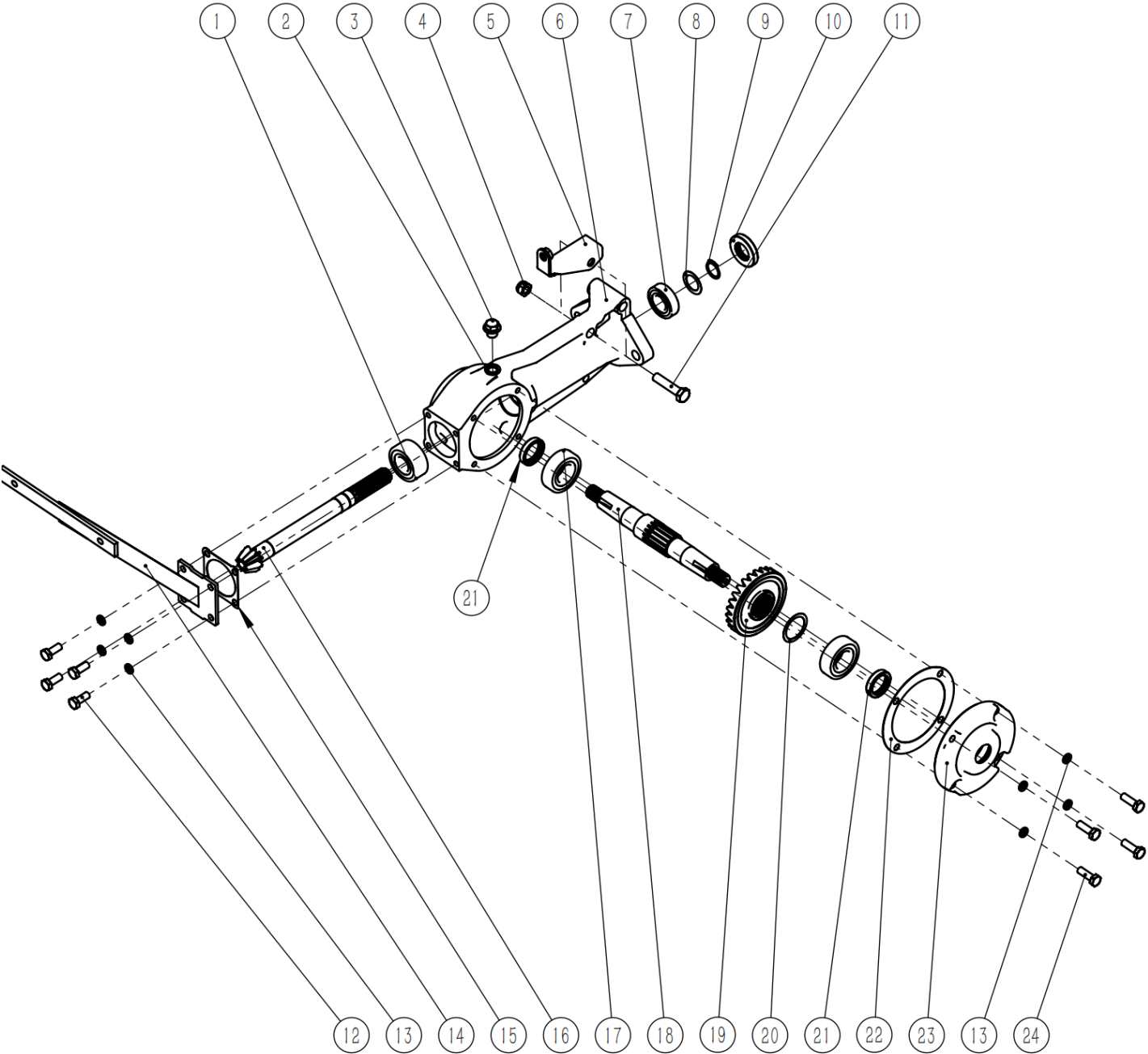

## GEAR BOX ASSEMBLY

No.	Product code	Description	Quantity
1	DUPGB/T 276-2013	deep groove ball bearing	1
2	DUPJB982-77	plug gasket	1
3	DUPJB/ZQ 4450-2006	out hexagonal plug	1
4	DUPGB/T 6182-2010	Hexagon lock nut with non-metallic insert	1
5		gear box cover assy	1
6	DUPYX7SX-04010000	gear box	1
7	DUPGB/T 276-2013	deep groove ball bearing	1
8	DUPYX7SX-04070000	main shaft adjust gasket	1
9	DUPGB/T 894.1-1986	Shaft with elastic retaining ring	1
10	DUPGB/T13871.1-200	skeleton oil seal	1
11	DUPGB/T 5782-2000	hexagon bolt	1
12	DUPGB/T 5783-2000	hexagon bolt full thread	4
13	DUPGB/T 93-1987	Elastic retaining ring	8
14	DUPYX7SX-04110000	fender support rod assy	1
15	DUPYX7SX-04090000	gear box front cover gasket	1
16	DUPYX7SX-04020000	main shaft	1
17	DUPGB/T 276-2013	deep groove ball bearing	2
18	DUPYX7SX-04050000	output shaft	1
19	DUPYX7SX-04030000	bevel gear	1
20	DUPYX7SX-04100000	bevel gear gasket	1
21	DUPGB/T13871.1-200	skeleton oil seal	2
22	DUPYX7SX-04060000	side cover gasket	1
23	DUPYX7SX-04040000	side cover	1
24	DUPGB/T5783-2000	hexagon bolt full thread	4