

# DUCAR

## 8500W Inverter generator DUED8600IR



## PARTS MANUAL

**MTI**  
CANADA

# GENERATOR

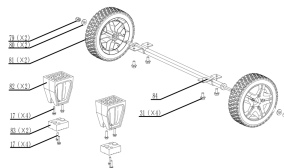
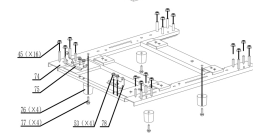
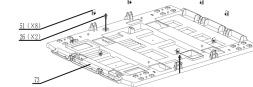
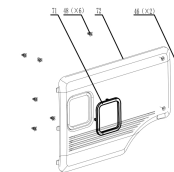
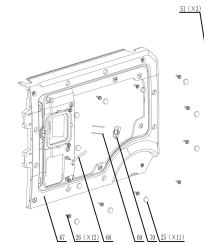
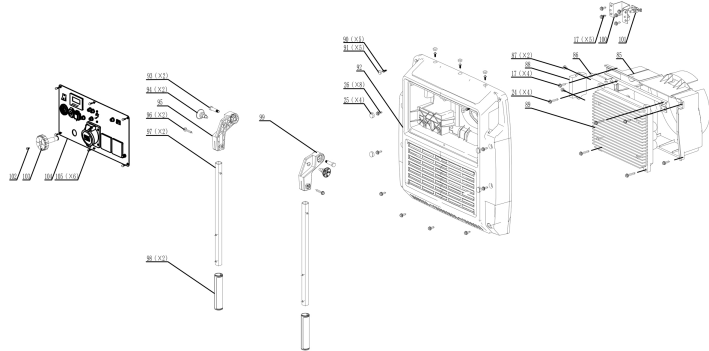
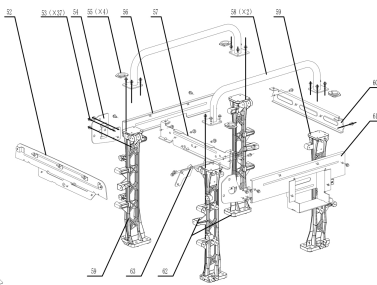
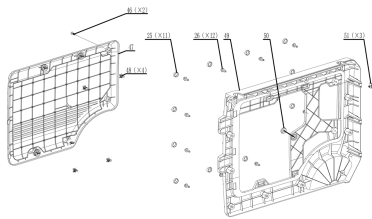
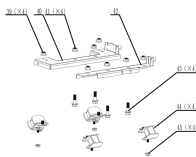
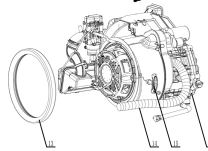
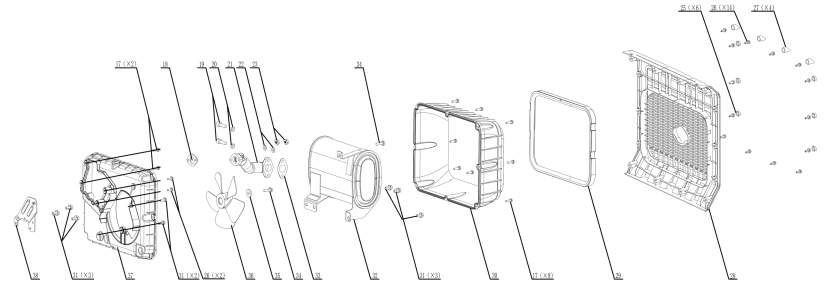
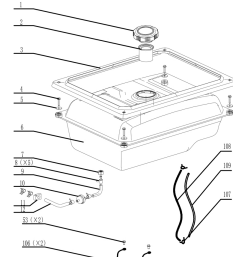

## GENERATOR

No.	Product code	Description	Quantity
1	DUP519429	FUEL CAP	1
2	DUP518801	FILTER ELEMENTS	1
3	DUP506382	TANK SEAL RING	1
4	DUP91336	BOLT M6×35	4
5	DUP96801	FLAT WASHER	4
6	DUP506380-057	FUEL TANK	1
7	DUP503782	FUEL OUTLET	1
8	DUP94408	FUEL LINE CLAMP Φ10	5
9	DUP96768	FUEL HOSE φ5×φ11×80mm	1
10	DUP503077	FILTER	1
11	DUP503044	CLIP	1
12	DUP96769	FUEL HOSE φ5×φ11×160mm	1
13	DUP507106	RECOIL SEAL RING	1
14	DUP506591	DEPUTY WIRING HARNESS	1
15	DUP500018	RECOIL HANDLE	1
16	DUP111004570396	ENGINE DH457i	1
17	DUP91397	BOLT M6×20	27
18	DUP96083	EXHAUST GASKET	1
19	DUP91115	BOLT M10×1.5×40	2
20	DUP94269	SPRING WASHER φ8	2
21	DUP507251	MUFFLER CONNECTING PIPE	1
22	DUP94201	SPRING WASHER φ10	2
23	DUP90051	NUT M8	2
24	DUP91331	BOLT M6X25	4
25	DUP506399	CAP,CENTRIFUGAL COVER	32
26	DUP91398	BOLT M6X16	52
27	DUP506400	CAP,CENTRIFUGAL COVER	4
28	DUP506361	MUFFLER COVER	1
29	DUP507124	EXHAUST SEALANT	1
30	DUP507101	MUFFLER COVER(REAR PANEL)	1
31	DUP91344	BOLT M8*16	12
32	DUP507170	MUFFLER	1
33	DUP96165	GASKET,BREATHER	1
34	DUP91346	BOLT M8*25	2
35	DUP96813	FLAT WASHER φ10.5×φ30×4	1
36	DUP507104	FAN	1
37	DUP507100	MUFFLER COVER(FRONT PANEL)	1
38	DUP507102	MUFFLER MOUNTING BRACKET	1
39	DUP90013	NUT M10*1.25	4
40	DUP507098	ENGINE LEFT CONNECTING BRACKET	1

No.	Product code	Description	Quantity
41	DUP90075	NUT M10*1.5	4
42	DUP507099	ENGINE RIGHT CONNECTING BRACKET	1
43	DUP91373	BOLT M10*35	4
44	DUP502021	ISOLATION SUPPORT	4
45	DUP90019	NUT M8	20
46	DUP92012	STOP BOLT M5X18	4
47	DUP506355-175A	LEFT PANEL	1
48	DUP504237	CLIP	10
49	DUP506357-175	LEFT FRAME	1
50	DUP500007	FUEL TANK SHOCK ABSORBER PAD A	1
51	DUP500060	LOCK CLIP	14
52	DUP506371	CROSSGIRDER, BACK CONTROL PANEL	1
53	DUP91442	BOLT M6X12	43
54	DUP506377	LEFT HANDLE BRACKET	1
55	DUP506383	GASKET,HANDLE	4
56	DUP506367	LEFT CROSSGIRDER	1
57	DUP506370	CROSSGIRDER,FUEL TANK	1
58	DUP506365	HANDLE	2
59	DUP506388	LEFT COLUMN	2
60	DUP506368	CROSSGIRDER,FUEL TANK	1
61	DUP506369	RIGHT CROSSGIRDER	1
62	DUP506389	RIGHT COLUMN	2
63	DUP506378	RIGHT HANDLE BRACKET	1
64	DUP507041	NEGATIVE LEAD	1
65	DUP506314	BATTERY	1
66	DUP506366	BATTERY HOLDER	1
67	DUP506358-175	RIGHT FRAME	1
68	DUP599601	METAL CLIP	1
69	DUP500661	BLIND RIVET Ø3*15MM	2
70	DUP500019-052	PULL ROPE GUIDE PLATE	1
71	DUP506379-052	ROPE DECORATIVE BOARD	1
72	DUP506356-175A	RIGHT PANEL	1
73	DUP506359	BOTTOM PLATE	1
74	DUP506364	MAIN BASEBOARD	1
75	DUP506374	LEFT INVERTER BRACKET	1
76	DUP507107	FOOT PAD	4
77	DUP91334	BOLTM6*30	4
78	DUP506373	RIGHT INVERTER BRACKET	1
79	DUP92373	NUT M8	2
80	DUP92304	FLAT WASHER Ø8x Ø28x2	2
81	DUP523681-175	WHEEL	2

No.	Product code	Description	Quantity
82	DUP506362	FOOT PAD	2
83	DUP506384	VIBRATION	2
84	DUP506381	AXLE	1
85	DUP506390	BACK COVER, INVERTER	1
86	DUP507108	INVERTER BRACKET	1
87	DUP92014	SCREW ST4.2X13	2
88	DUP506234	CONTROL MODULE	1
89	DUP507012	INVERTER MODULE	1
90	DUP91825	SCREW M5*12	5
91	DUP506385	CAP,CENTRIFUGAL COVER	5
92	DUP506360	PANEL REAR COVER	1
93	DUP527611	HANDLE MOUNTING BOLT	2
94	DUP527411	HANDLE VALVE RETAINER ASSEMBLY	2
95	DUP506393	LEFT HANDLE CONNECTION BLOCK	1
96	DUP91335	BOLTM6*35	2
97	DUP506387	HANDLE	2
98	DUP94515-175	RUBBER SLEEVE	2
99	DUP506394	RIGHT HANDLE CONNECTION BLOCK	1
100	DUP506403	SINGLE FUEL SWITCH ASSEMBLE BRACKET	1
101	DUP503062	FUEL SWITCH	1
102	DUP92032	SCREW M4X16	1
103	DUP506363	FUEL SWITCH KNOB	1
104	DUP506460	PANEL ASSEMBLY	1
105	DUP92093	SCREW M6*10	6
106	DUP506203	SHORT WIRE	2
107	DUP94477	FUEL LINE CLAMP $\Phi 7*0.8$	2
108	DUP95084	TUBE,BREATHER	1
109	DUP94519	FIBERGLASS PIPE	1
	DUP9348	REMOTE STARTER	1

# ENGINE



No.	Product code	Description	Quantity
1	DUP441501	CONNECTING ROD ASSEMBLY	1
2	DUP92158	SCREW M5*25	2
3	DUP91349	BOLT M8*40	7
4	DUP93513	OIL SEAL	2
5	DUP275903	EXHAUST VALVE	1
6	DUP271704	INTAKE VALVE	1
7	DUP440018	CONNECTING PIPE	1
8	DUP449903	WIRE SLEEVE	1
9	DUP261805	EXHAUST VALVE SPRING SEAT	2
10	DUP94227	STEEL WASHER	1
11	DUP599601	METAL CLIP	3
12	DUP96078	GASKET	1
13	DUP445501	PISTON PIN	1
14	DUP441201	PISTON	1
15	DUP93544	OIL SEAL	2
16	DUP91072	BOLT M6/M8*142	2
17	DUP91995	BOLT M12×1.5x90	4
18	DUP91342	BOLT M8*12	1
19	DUP442001	CAMSHAFT ASSEMBLY	1
20	DUP390600	OIL PUMP COVER	1
21	DUP440020	AIR FILTER ASSEMBLY	1
22	DUP440501	WIND-LEAD-COVER	1
23	DUP440503	WIND-LEAD-COVER	1
24	DUP440601	COVER	1
25	DUP449901	CRIMPING BLOCK	1
26	DUP440304	HOOP	1
27	DUP444701-052	RECOIL STARTER ASSEMBLY	1
28	DUP444501	STARTER PULLEY	1
29	DUP444502	WIND-LEAD-COVER	1
30	DUP444601	IMPELLER	1
31	DUP440019	AIR FILTER BRACKET	1
32	DUP271008	CYLINDER HEAD	1
33	DUP271604	PISTON RING ASSEMBLY	1
34	DUP261301	PISTON PIN RING	2
35	DUP265102	OIL SENSOR	1
36	DUP97450	STARTING MOTOR ASSEMBLY	1
37	DUP440303	CRANKSHAFT	1
38	DUP97109	SPARK PLUG	1
39	DUP399900	OIL PUMP ASSEMBLY	1
40	DUP240901	CRANKCASE LOCATING PIN	2
41	DUP94257	FLAT WASHER	1

No.	Product code	Description	Quantity
42	DUP92239	BOLT M3*8	4
43	DUP96264	GASKET	1
44	DUP96249	GASKET	1
45	DUP96346	GASKET	1
46	DUP95692	EXHAUST PIPE	1
47	DUP399912	SEALING RING	1
48	DUP440014	BALANCE SHAFT	1
49	DUP449915	SEALING SCREW	1
50	DUP265602-138	DIPSTICK ASSEMBLY	1
51	DUP94292	FLAT WASHER	2
52	DUP91015	BOLT M8*54	2
53	DUP91457	BOLT M8*76	3
54	DUP266002	VALVE SPRING	2
55	DUP449907	SPRING	1
56	DUP504739	TEMPERATURE SENSOR	1
57	DUP440008	IGNITION COIL	1
58	DUP507232	STATOR	1
59	DUP507233	ROTOR	1
60	DUP266102	VALVE LIFTER	2
61	DUP261806	TOP CAP	2
62	DUP481901	PUSH ROD	2
63	DUP440017	CRANKCASE	1
64	DUP440102	CRANKCASE COVER	1
65	DUP91817	BOLT M12*1.5*15	1
66	DUP94004	FLAT WASHER	2
67	DUP449908	STEEL BALL	1
68	DUP449916	CLAMP	2
69	DUP449917	OIL DRAIN ASSEMBLY	1
70	DUP442301	CARBURETOR CONNECTION BLOCK	1
71	DUP90004	NUT M16*1.5	1
72	DUP91329	BOLT M6X16	14
73	DUP91325	BOLT M6X12	8
74	DUP442101	ROCKER ARM ASSEMBLY	2
75	DUP260802	VALVE LOCK CLIP	4
76	DUP482101	ROCKING ARM SHAFT	2
77	DUP440002	STEPPER MOTOR	1
78	DUP440003	STEPPER MOTOR	1
79	DUP96789	FUEL LINE	1
80	DUP91346	BOLT	2
81	DUP91330	BOLT	9
82	DUP96081	GASKET	1

No.	Product code	Description	Quantity
83	DUP94291	FLAT WASHER	1
84	DUP380901	LOCATING PIN	2
85	DUP90016	NUT M6	2
86	DUP440026	CARBURETOR ASSEMBLY	1
87	DUP449913	OIL OUTLET PIPE	1
88	DUP441101	CYLINDER HEAD COVER	1
89	DUP449911	OIL FILTER	1
90	DUP503034	FUEL LINE CLAMP $\varphi 9.5 \times 0.8$	1
91	DUP440021	RESONANT CAVITY ASSEMBLY	1