

# OPERATOR'S MANUAL

**MODEL:** DJ154F  
DJ156F  
DJ162F  
DJ165F  
DJ168F  
DJ170F  
DJ177F  
DJ188F  
DJ190F  
DJ192F





Diagrams within this manual may not be drawn proportionally. Due to continuing improvements, actual product may differ slightly from the product described herein.

**⚠ WARNING**

**READ AND FOLLOW ALL SAFETY RULES AND INSTRUCTIONS IN THIS MANUAL  
BEFORE ATTEMPTING TO OPERATE THIS MACHINE.  
FAILURE TO COMPLY WITH THESE INSTRUCTIONS MAY RESULT IN PERSONAL INJURY.**

# Safety References

The safety alert symbol  is used to identify safety information about hazards that can result in personal injury. A signal word (DANGER, WARNING, or CAUTION) is used with the alert symbol to indicate the likelihood and the potential severity of injury. In addition, a hazard symbol may be used to represent the type of hazard.

 **DANGER** indicates a hazard which, if not avoided, **will result in death or serious injury.**

 **WARNING** indicates a hazard which, if not avoided, **could result in death or serious injury.**

 **CAUTION** indicates a hazard which, if not avoided, **might result in minor or moderate injury.**

**CAUTION**, when used **without** the alert symbol, indicates a situation that **could result in damage to the engine.**



















  This manual contains safety information to make you aware of the hazards and risks associated with engines, and how to avoid them. Because we do not necessarily know what equipment this engine will power, it is important that you read and understand these instructions and the instructions for the equipment this engine powers.

Table of Contents	
Safety References .....	2
Features .....	3
Safety .....	4
Starting .....	5
Stopping .....	5
Troubleshooting .....	6
Oil .....	6
Fuel .....	7
Maintenance .....	8
Storage .....	10
Specifications .....	11
Warranty Information .....	13
Emission Information .....	14

# SYMBOLS ASSOCIATED WITH THIS ENGINE:

	Fire		Read Manual
	Explosion		Oil
	Kickback		Fuel
	Hot Surface		Fuel Shutoff
	Toxic Fumes		Hazardous Chemical
	Moving Parts		Choke
	Shock		Stop
	Slow		Fast

 <b>WARNING</b>
We do not approve or authorize the use of these engines on 3-wheel All Terrain Vehicles (ATVs), motor bikes, fun/recreational go-karts, aircraft products or vehicles intended for use in competitive events. Use of these engines in such applications could result in property damage, serious injury (including paralysis), or even death.

 <b>WARNING</b>
The engine exhaust from this product contains chemicals known to the State of California to cause cancer, birth defects, or other reproductive harm.

<b>CAUTION</b>
This engine is shipped from us without oil. If you start the engine without oil, the engine will be damaged beyond repair and will not be covered under warranty.

## Features and Controls

Compare the illustration with your engine to familiarize yourself with the location of various features and controls.

- A Air cleaner
- B Muffler  
Muffler Guard (Optional)
- C Spark plug
- D Throttle lever
- E Recoil starter
- F Engine switch
- G Breaker (Electric start type)
- H Starting handle
- I Fuel cock
- J Choke lever
- K Fuel filler cap
- L Fuel tank
- M Starting motor (Electric start type)
- N Engine identification
- O Dipstick
- P Drain plug

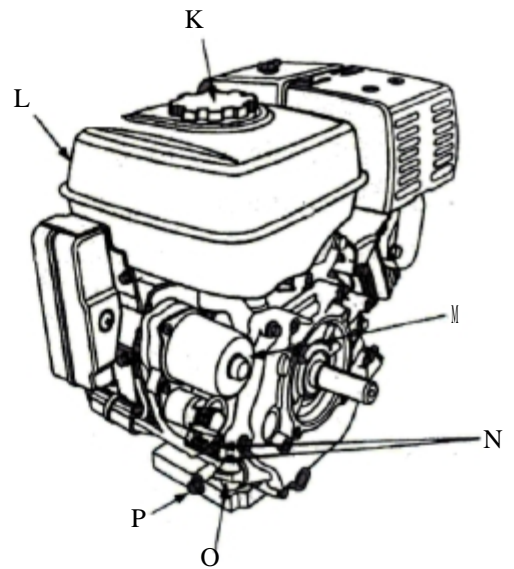
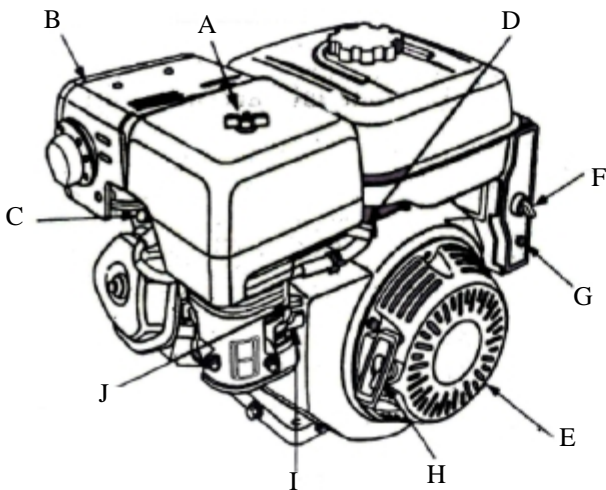

# Safety

<b>CAUTION</b>
This engine is shipped from us without oil. If you start the engine without oil, the engine will be damaged beyond repair and will not be covered under warranty.

 <b>WARNING</b>
Gasoline and its vapors are extremely flammable and explosive. Fire or explosion can cause severe burns or death.

### WHEN ADDING FUEL

- Turn engine OFF and let engine cool at least 2 minutes before removing gas cap.
- Fill fuel tank outdoors or in well-ventilated area.
- Do not overfill fuel tank.
- Keep gasoline away from sparks, open flames, pilot lights, heat, and other ignition sources.
- Check fuel lines, tank, cap, and fittings frequently for cracks or leaks. Replace if necessary.

### WHEN STARTING ENGINE

- Make sure spark plug, muffler, fuel cap and air cleaner are in place.
- Do not crank engine with spark plug removed.
- If fuel spills, wait until it evaporates before starting engine.
- If engine floods, set choke to OPEN/RUN position, place throttle in FAST and crank until engine starts.

### WHEN OPERATING EQUIPMENT

- Do not choke carburetor to stop engine.



### WHEN TRANSPORTING EQUIPMENT

- Transport with fuel tank EMPTY.



### WHEN STORING GASOLINE OR EQUIPMENT WITH FUEL IN TANK



- Store away from furnaces, stoves, water heaters or other appliances that have pilot light or other ignition source because they can ignite gasoline vapors.

 <b>WARNING</b>
Starting engine creates sparking. Sparking can ignite nearby flammable gases. Explosion and fire could result.
<ul style="list-style-type: none"><li>• If there is natural or LP gas leakage in area, do not start engine.</li><li>• Do not use pressurized starting fluids because vapors are flammable.</li></ul>

 <b>WARNING</b>
 Rapid retraction of starter cord (kickback) will pull hand and arm toward engine faster than you can let go. Broken bones, fractures, bruises or sprains could result.
<ul style="list-style-type: none"><li>• When starting engine, pull cord slowly until resistance is felt, then pull rapidly.</li><li>• Direct coupled equipment components such as, but not limited to, blades, impellers, pulleys, sprockets, etc., must be securely attached.</li></ul>

 <b>WARNING</b>
 Rotating parts can contact or entangle hands, feet, hair, clothing, or accessories. Traumatic amputation or severe laceration can result.
<ul style="list-style-type: none"><li>• Operate equipment with guards in place.</li><li>• Keep hands and feet away from rotating parts.</li><li>• Tie up long hair and remove jewelry.</li><li>• Do not wear loose-fitting clothing, dangling drawstrings or items that could become caught.</li></ul>

 <b>WARNING</b>
 Engines give off carbon monoxide, an odorless, colorless, poison gas. Breathing carbon monoxide can cause nausea, fainting or death.
<ul style="list-style-type: none"><li>• Start and run engine outdoors.</li><li>• Do not start or run engine in enclosed area, even if doors or windows are open.</li></ul>

 <b>WARNING</b>
 Running engines produce heat. Engine parts, especially muffler, become extremely hot. Severe thermal burns can occur on contact. Combustible debris, such as leaves, grass, brush, etc. can catch fire.
<ul style="list-style-type: none"><li>• Allow muffler, engine cylinder and fins to cool before touching.</li><li>• Remove accumulated debris from muffler area and cylinder area.</li><li>• Install and maintain in working order a spark arrester before using equipment on forest-covered, grass-covered, brush-covered unimproved land. The state of California requires this. Other states may have similar laws. Federal laws apply on federal land.</li></ul>

## How to Start the Engine



### WARNING



Gasoline and its vapors are extremely flammable and explosive.



Fire or explosion can cause severe burns or death.

### When Starting Engine

- Engine that spark plug, muffler, fuel cap and air cleaner are in place and secured.
- Do not crank engine with spark plug removed.
- If engine floods, set choke (if equipped) to open/run position, move throttle (if equipped) to fast position and crank until engine starts.



### WARNING



Engines give off carbon monoxide, an odorless colorless, poison gas.

Breathing carbon monoxide can cause nausea, fainting or death.

- Start and run engine outdoors.
- Do not start or run engine in enclosed area, even if doors or windows are open.



### WARNING



Unintentional sparking can result in fire or electric shock.



Unintentional start-up can result in entanglement, traumatic amputation, or laceration.



### Fire hazard

- A 3-wire extension cord. (It is optional)
  - First attach extension cord to electric starter connector and then into a wall receptacle. If additional extension cord is required, use a 3-wire.
  - If the supply cord is damaged, it must be replaced by the manufacturer or its service agent or a similarly qualified person in order to avoid a hazard.
1. Check the oil level. See the **How to Check/Add Oil** section.
  2. Move the fuel cock (I) to the ON position.
  3. Move the choke lever (J) the choke  position.  
*Note:* Choke is usually unnecessary when restarting a warm engine.
  4. Move Throttle lever (D) away from MIN. position, about 1/3 of way toward MAX. position.
  5. Turn the Engine switch (F) to the ON position.
  6. **Recoil Start:** Firmly hold the starting handle (H). Pull the starter cord handle slowly until resistance is felt, the pull rapidly.



**WARNING:** Rapid retraction of the starter cord (kickback) will pull your hand and arm toward the engine faster than you can let go. Broken bones, fractures, bruises or sprains could result. When starting engine, pull the starter cord slowly until resistance is felt and then pull rapidly to avoid kickback.

### 7. Electric Start: (It is optional)

Turn the key to the Start position, then hold it there until the engine starts.

**Note:** If engine fails to start within 5 seconds, release the key, and wait at least 10 seconds before operating the starter again.

## How to Stop the Engine



### WARNING



Gasoline and its vapors are extremely flammable and explosive.



Fire or explosion can cause severe burns or death.

1. Move Throttle lever (D) to MIN. position.
2. Turn Engine switch (F) to the OFF position.
3. Turn Fuel cock (I) to the OFF position.

## Troubleshooting

### Engine will not start

#### Out of fuel

- If engine is cold, ensure choke lever is set correctly.
- Add fuel

#### Engine flooded

- Set choke lever to open/run position

#### Fouled spark plug/engine fails to product spark

- Remove spark plug and clean it. Check the spacing on the electrode and set the gap to the correct dimension. See Maintenance Section. If plug is damaged, replace with a new spark plug.
- Ensure the spark plug is installed and wire is connected.

#### Electric starting

- (It is optional) Check battery capacity and Fuse is burnt out or not.



#### Warning:

- Do not crank engine with spark plug removed.

## Oil

### Oil Recommendations

- We recommend the use of our Warranty Certified oils for best performance. Other high-quality detergent oils are acceptable if classified for service SF, SG, SH, SJ or higher.
- Do not use special additives.
- Outdoor temperatures determine the proper oil viscosity for the engine. Use the chart to select the best viscosity for the outdoor temperature range expected.

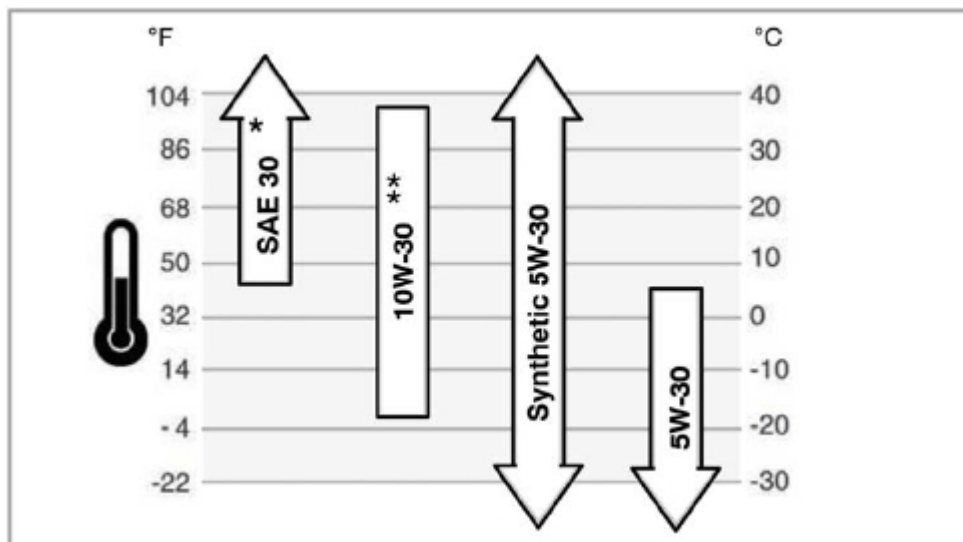

**Note:** Below 40 °F (4 °C) the use of SAE 30 will result in hard starting.  
 Above 80 °F (27 °C) the use of 10W-30 may cause increased oil consumption. Check oil level more frequently.

### Before adding or checking the oil

- Place engine level.
- Clean the oil fill area of any debris.

## How to Check/Add Oil

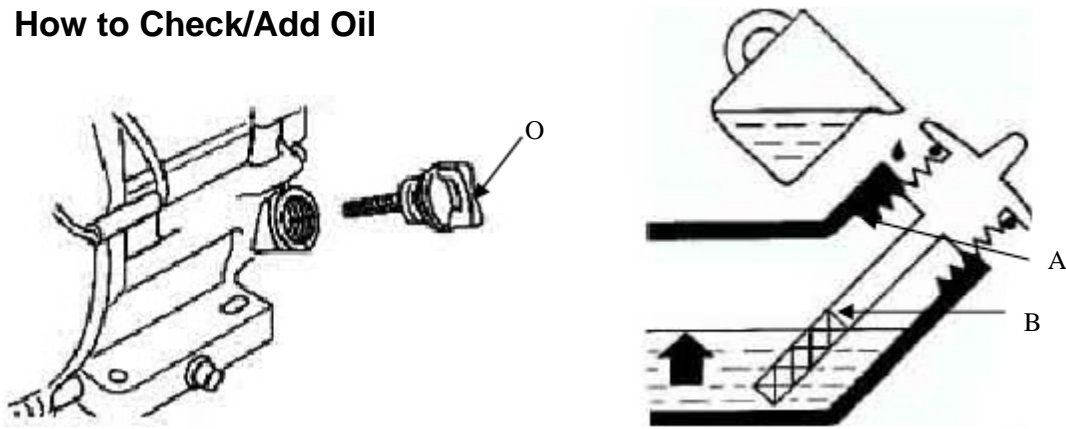

Figure 1

1. Remove the dipstick (O) and swipe with a clean cloth (Figure 1).
2. Insert the dipstick into the filler neck without screwing it in.
3. Remove the dipstick and check the oil level. Make sure the oil is at the FULL mark (B) on the dipstick.
4. To add oil, pour the oil slowly into the engine oil fill (A). **Do not overfill.** After adding oil, wait one minute and then recheck the oil level.
5. Replace and tighten the dipstick.

### Fuel Recommendations

#### Fuel must meet these requirements:

- Clean, fresh, unleaded gasoline.
- A minimum of 87 octane/87 AKI (91 RON). High altitude use, see below.
- Gasoline with up to 10% ethanol (gasohol) or up to 15% MTBE (methyl tertiary butyl ether) is acceptable.

**CAUTION:** Do not use unapproved Gasoline, such as E85. Do not mix oil in gasoline or modify the engine to run on alternate fuels. This will damage the engine components and void the engine warranty. To protect the fuel system from gum formation, mix a fuel stabilizer into the fuel. See **Storage**. All fuel is not the same. This engine is certified to operate on gasoline. The emissions control system for this engine is EM (Engine Modifications).

### High Altitude Operation

Your engine is configured for operation below 2,000 feet altitude at the factory. Your engine must be reconfigured for operation above 2,000 feet altitude. Operating the engine with the wrong engine configuration at a given altitude may increase its emissions, decrease fuel efficiency, degrade performance, and cause irreversible damage. Engines configured for high altitude operation cannot be operated in standard altitude conditions. A qualified service center should ensure that your engine is properly configured for your location.

### How to Add Fuel



#### WARNING

**Gasoline and its vapors are extremely flammable and explosive.**



**Fire or explosion can cause severe burns or death.**



#### When Adding Fuel

- Turn engine off and let engine cool at least 2 minutes before removing the fuel cap.
- Fill fuel tank outdoors or in well-ventilated area.
- Do not overfill fuel tank. Fill tank to approximately 1.5 inches (38 mm) below top of neck to allow for fuel expansion.



- Keep gasoline away from sparks, open flames, pilot lights, heat, and other ignition sources.
  - Check fuel lines, tank, cap, and fittings frequently for cracks or leaks. Replace if necessary.
  - If fuel spill, wait until it evaporates before starting engine.
1. Clean the fuel cap area of dirt and debris. Remove the fuel cap.
  2. Fill the fuel tank with gasoline. To allow for expansion of the gasoline, do not fill above the bottom of the fuel tank neck.
  3. Reinstall the fuel cap.

## Maintenance

**Use only original equipment replacement parts. Other parts may not perform as well, may damage the unit, and may result in injury.** In addition, use of other parts may void your warranty.

We recommend that you see any ours' for all maintenance and service of the engine and engine parts.

**CAUTION:** All the components used to build this engine must remain in place for proper operation.



### WARNING



**Unintentional sparking can result in fire or electric shock.**



**Unintentional start-up can result in entanglement, traumatic amputation, or laceration.**



**Fire hazard**

#### **Before performing adjustments or repairs:**

- Disconnect the spark plug wire and keep it away from the spark plug.
- Use only correct tools.
- Do not tamper with governor spring, links or other parts to increase engine speed.
- Replacement parts must be the same and installed in the same position as the original parts.
- Do not strike the flywheel with a hammer or hard object because the flywheel may later shatter during operation.

#### **When testing for spark:**

- Use approved spark plug tester.
- Do not choke for spark with spark plug removed.

## Maintenance Chart

<b>First 5 Hours</b>
<ul style="list-style-type: none"> <li>• Change oil</li> </ul>
<b>Every 8 Hours or Daily</b>
<ul style="list-style-type: none"> <li>• Check engine oil level</li> </ul>
<b>Every 50 Hours or Annually</b>
<ul style="list-style-type: none"> <li>• Change engine oil</li> <li>• Check muffler and muffler guard and spark Arrester (if applicable)</li> </ul>
<b>Annually</b>
<ul style="list-style-type: none"> <li>• Replace spark plug</li> <li>• Check valve clearance</li> </ul>

## Carburetor Adjustment

Never make adjustments to the carburetor. The carburetor was set at the factory to operate efficiently under most conditions. However, if adjustments are required, see any our Authorized Dealer for service.

**CAUTION:** The manufacturer of the equipment on which this engine is installed specifies the top speed at which the engine will be operated. **Do not exceed** this speed.



## How to Replace the Spark Plug



Check the gap (A) with a wire gauge (B). If necessary, reset the gap. Install and tighten the spark plug to the recommended torque. For gap setting or torque, see the **Specifications** section.

*Note:* In some areas, local law requires using a resistor spark plug to suppress ignition signals. If this engine was originally equipped with a resistor spark plug, use the same type for replacement.

## Inspect Muffler and Spark Arrester (if applicable)



### WARNING



Running engines produce heat. Engine parts, especially muffler, become extremely hot.



Severe thermal burns can occur on contact.

Combustible debris, such as leaves, grass, brush, etc. can catch fire.

- Allow muffler, engine cylinder and fins to cool before touching.
- Remove accumulated debris from muffler area and cylinder area.

**WARNING:** Replacement parts must be the same and installed in the same position as the original parts or fire could result.

## How to Service the Air Filter (see figure 2)

1. Remove the air cleaner outside cover (A). Be careful to prevent dirt and debris from falling into the air cleaner assembly.
2. Separate the Air Filter (A) from the Air Filter Housing (B).
3. Inspect the air filter. Clean dirty air filter with warm water and mild soap. Allow air filter to dry thoroughly before re-installation
4. Install the air filter assembly onto the carburetor and secure with screw.

**Note:** Do not use pressurized air or solvents to clean the filter. Pressurized air can damage the filter and solvents will dissolve the filter.

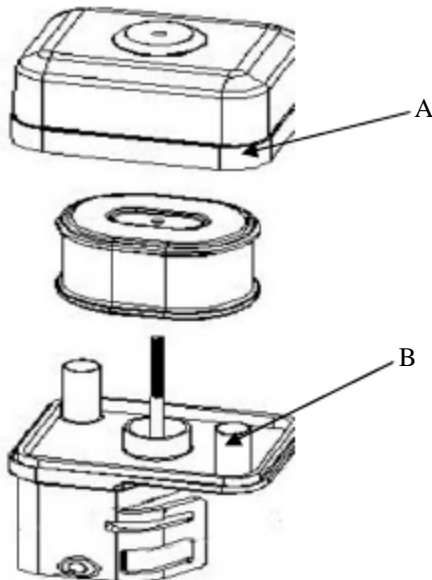

Figure 2

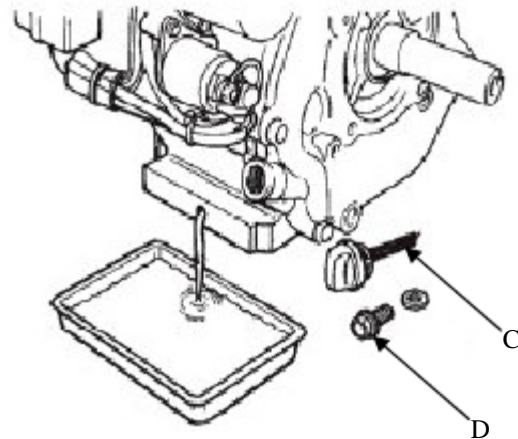

Figure 3

## How to Remove Oil

**Caution:** Used oil is a hazardous waste product and must be disposed of properly. Do not discard with household waste. Check with your local authorities, service center, or dealer for safe disposal/recycling facilities.

### Removing Oil

The oil must be drained from the Oil Drain Plug (See figure 3)

1. Remove the dipstick (C)
2. Place an approved container below the oil drain plug.
3. Remove the Oil drain plug (D) and allow oil to drain into the approved container.
4. Install Oil drain plug (D) and wrench tighten.



**WARNING:** When you drain the oil from the oil drain plug, the fuel tank must be empty or fuel can leak out and result in fire or explosion. To empty the fuel tank, run engine until it stops from lack of fuel.

## How to Service the Battery -see figure 4 (if applicable)



**WARNING:** Be careful not to connect the battery in reverse polarity, as this will short circuit the battery charging system.

**Note:** Use a 12-volt battery with an ampere-hour rating of at least 18 Ah.

1. Connect the positive (+) cable to the starter solenoid terminal.
2. Connect the negative (-) cable to an engine mounting bolt or other good engine ground connection.
3. Connect the positive (+) cable to the positive (+) terminal.
4. Connect the negative (-) cable to the negative (-) terminal.
5. Coat terminals and cable ends with grease.

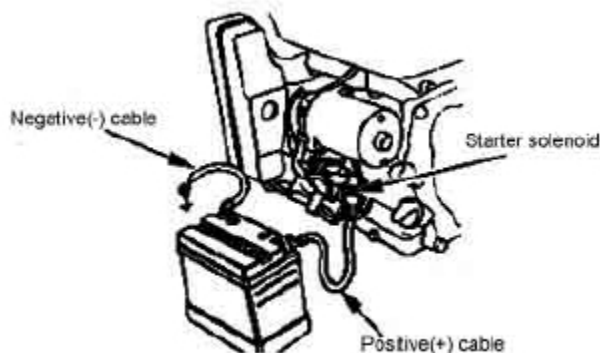

figure4

## Storage



**WARNING:**

**When storing fuel or equipment with fuel in tank:**

- Store away from furnaces, stoves, water heaters, or other appliances that have a pilot light or other ignition source because they can ignite vapors.

**When Transporting Equipment:**

- Transport with fuel tank EMPTY or with fuel shut-off valve OFF.

The following precautions should be taken if storing your trimmer unit for a period exceeding 30 days, or for seasonal storage.

- While engine is still warm, change oil.
- Clean engine of surface debris, chaff or grass.
- Drain all fuel from fuel tank into proper receptacle for storage.
- Remove spark plug. Place 1 teaspoon or 5 ml. of oil into spark plug hole.
- Pull starter rope **slowly** 8-10 times to properly coat the cylinder bore and piston for storage. Replace spark plug and tighten. Any residual oil may burn off in subsequent starts. This may result in white smoke emission from muffler.
- This trimmer may be stored in a variety of positions. It is best to store in horizontal position with the spark plug up. Do not store or transport with the spark plug down.

**Note:** Storing or transporting with the spark plug down will result in hard starting and/or engine smoking.

- Store in a clean dry area.
- When removing unit from storage, only use fresh gasoline. Perform operation checks (see maintenance schedule) before starting engine.

\*\* Engine power will decrease 3.5% for each 1,000 feet (300 meters) above sea level and 1% for each 10°F (5.6°C) above 77°F (25°C). The engine will operate satisfactorily at an angle up to 15°. Refer to the equipment operator's manual for safe allowable operating limits on slopes.

We recommend that you see and our Authorized Dealer for all maintenance and service of the engine and engine parts. Use only our genuine parts.

## Engine Specification

<b>Model</b>	154F(DH79)	156F (DH98)	162F(DH127)	165F(DH180)	168F(DH196)	170F(DH208)	177F(DH270)	188F(DH389)	190F(DH420)
<b>Displacement</b>	79cc	98cc	127cc	180cc	196cc	208cc	270cc	389cc	420cc
<b>Bore</b>	54mm(2.12in)	56mm(2.20in)	62mm(2.44in)	65mm(2.56in)	68mm(2.68in)	70mm(2.76in)	77mm(3.03in)	88mm(3.46in)	90mm(3.54in)
<b>Stroke</b>	34.4mm(1.35in)	40mm(1.58in)	42mm(1.65in)	54mm(2.12in)	54mm(2.12in)	54mm(2.12in)	58mm(2.28in)	64mm(2.52in)	66mm(2.60in)
<b>Oil Capacity</b>	0.4L(0.11gal)	0.4L(0.11gal)	0.6L(0.16gal)	0.6L(0.16gal)	0.6L(0.16gal)	0.6L(0.16gal)	0.95L(0.25gal)	1.1L(0.29gal)	1.1L(0.29gal)
<b>Net Weight</b>	10kg	10kg	12.5kg	14.5kg	15kg	15.5kg	24kg	30kg	30.5kg

## Tune-up Specification

<b>Model</b>	154F(DH79) / 156F (DH98)	162F(DH127) / 165F(DH180) / 168F(DH196) / 170F(DH208) / 177F(DH270) / 188F(DH389) / 190F(DH420)
<b>Spark Plug Gap</b>	0.6-0.7mm(0.024-0.028in)	0.7-0.8mm(0.028-0.03in)
<b>Spark Plug Torque</b>	18-22N.m	18-22N.m
<b>Intake Valve Clearance</b>	0.08-0.12mm(0.003-0.005in)	0.08-0.12mm(0.003-0.005in)
<b>Exhaust Valve Clearance</b>	0.13-0.18mm(0.005-0.007in)	0.13-0.18mm(0.005-0.007in)